

this document brought to you by  
**AED Superstore**

# Medtronic LIFEPAK 500 AED Manual

Get an original copy of the Medtronic LIFEPAK 500 AED Manual for manufacturer information about service, available accessories and how to use and maintain your device.

**800.544.0048**  
**AEDSuperstore.com**

---

# LIFEPAK<sup>®</sup> 500

Automated External Defibrillator  
with cprMAX<sup>™</sup> Technology



## Operating Instructions

---





**OPERATING INSTRUCTIONS**

**LIFEPAK® 500**

Automated External Defibrillator with cprMAX Technology

---

## IMPORTANT

**[!USA]** Federal (USA) law restricts this device to sale by or on the order of a physician. This automated external defibrillator (AED) is to be used by authorized personnel only.

## Device Tracking

**[!USA]** The U.S. Food and Drug Administration requires defibrillator manufacturers and distributors to track the location of their defibrillators. The address to which this particular device was shipped is now listed as the current tracking location. If the device is located somewhere other than the shipping address or the device has been sold, donated, lost, stolen, exported, or destroyed, or if the AED was not obtained directly from Medtronic, please either call the device tracking coordinator at 1.800.426.4448 or use one of the postage-paid address change cards located in the back of this manual to update this vital tracking information.

## Responsibility for Information

It is the responsibility of our customers to ensure that the appropriate person(s) within their organization have access to this information, including general safety information provided in Section 1.

## Revision History

These operating instructions describe LIFEPAK 500 devices with biphasic defibrillation waveform (software version 6.0 or later). Older devices may not have all the features described in this manual.



### Medtronic Emergency Response Systems

11811 Willows Road Northeast  
Redmond, WA 98052-2003 USA  
Telephone: 425.867.4000  
Toll Free (USA only): 800.442.1142  
Fax: 425.867.4121  
Internet: [www.medtronic-ers.com](http://www.medtronic-ers.com)  
[www.medtronic.com](http://www.medtronic.com)

### Medtronic Europe S.A.

Medtronic Emergency Response Systems  
Rte. du Molliau 31  
Case postale 84  
1131 Tolochenaz  
Switzerland  
Telephone: 41.21.802.7000  
Fax: 41.21.802.7900

---

LIFEPAK and FAST-PATCH are registered trademarks of Medtronic Emergency Response Systems, Inc. CODE SUMMARY, cprMAX technology, QUIK-COMBO, QUIK-VIEW, Data Transfer, REDI-PAK, Shock Advisory System, CODE-STAT, and PARTSLINE are trademarks of Medtronic Emergency Response Systems, Inc. Medtronic is a registered trademark of Medtronic, Inc. Hayes and ACCURA are trademarks of Zoom Technologies. U.S. Robotics and Sportster are registered trademarks of U.S. Robotics. Microsoft and Windows are registered trademarks of Microsoft Corporation. EPSON and EPSON ESC/P are registered trademarks of Seiko Epson Corporation. Specifications are subject to change without notice. ©1996-2006 Medtronic Emergency Response Systems, Inc. All rights reserved.

Publication Date 8/2006

MIN 3005338-011 / CAT. 26500-002364

# TABLE OF CONTENTS

---

## Preface

About Defibrillation .....	x
Operator Considerations.....	x
Indications for Use .....	xi
LIFEPAK 500 Automated External Defibrillator.....	xi
Features of the LIFEPAK 500 AED .....	xi

---

## 1 Safety Information

Terms .....	1-2
General Warnings and Cautions .....	1-2
Symbols .....	1-3

---

## 2 Getting Ready

Unpacking and Initial Inspection .....	2-2
Controls, Indicators, and Connectors .....	2-2
About Batteries .....	2-5
Setting the Clock .....	2-6
Defining Setup Options.....	2-7
Default Settings .....	2-12
Changing Setup Options.....	2-13
Transferring Setup to Another LIFEPAK 500 AED .....	2-16
Connecting Electrodes to the AED .....	2-17

<b>3</b>	<b>Using the LIFEPAK 500 AED</b>	
	Warnings and Cautions.....	3-2
	Preparing the AED for Operation .....	3-2
	AED Operation .....	3-3
	AED Prompts.....	3-5
	Transferring Patient Care to another AED .....	3-9
	Troubleshooting During Patient Care .....	3-10
<b>4</b>	<b>Data Management</b>	
	Overview of Data Storage and Retrieval.....	4-2
	Sending Data to a Computer by Modem.....	4-5
	Sending Data to a Computer by Direct Connection .....	4-8
<b>5</b>	<b>Maintenance</b>	
	Maintenance and Testing Scheduling.....	5-2
	Inspection .....	5-2
	Cleaning.....	5-4
	Testing.....	5-4
	Battery Maintenance .....	5-7
	Electrode Storage .....	5-13
	Service and Repair.....	5-13
	Warranty.....	5-14
	Supplies, Accessories, and Training Tools .....	5-14
	Specifications.....	5-15
	Clinical Summary: Defibrillation of Ventricular Fibrillation and Ventricular Tachycardia.....	5-20
<b>6</b>	<b>Troubleshooting</b>	
	Patient Care.....	6-2
	Modem Data Transfer .....	6-4
	Setup Transfer .....	6-5
	Screen Messages .....	6-5
	Voice Prompts .....	6-7
	<b>Appendix A: Shock Advisory System</b>	
	<b>Appendix B: LIFEPAK 500 Operator’s Checklist</b>	
	<b>Appendix C: FAST-PATCH Defibrillation Cable Instructions for Use</b>	
	<b>Appendix D: Declarations of Conformity / Electromagnetic Compatibility Guidance</b>	
	<b>Index</b>	

## LIST OF FIGURES

Figure 2-1	LIFEPAK 500 AED controls, indicators, and connectors .....	2-2
Figure 2-2	Accessories for the LIFEPAK 500 AED .....	2-4
Figure 2-3	Battery installation.....	2-5
Figure 2-4	Setup transfer connections .....	2-17
Figure 2-5	Connecting the QUIK-COMBO electrodes .....	2-18
Figure 3-1	Anterior-lateral position.....	3-3
Figure 3-2	Anterior-posterior placement .....	3-4
Figure 4-1	Data stored by the LIFEPAK 500 AED .....	4-2
Figure 4-2	Comparison of data stored for the Current Patient and Previous Patient .....	4-3
Figure 4-3	Data stored when the AED stores a new patient record.....	4-4
Figure 4-4	Equipment connections for data transfer by modem .....	4-7
Figure 4-5	Equipment connections for data transfer by direct connection to a computer.....	4-9
Figure 5-1	Test load connection .....	5-6
Figure 5-2	Active life, no patient use .....	5-9
Figure 5-3	Active life, one patient use per year.....	5-9
Figure 5-4	Active life, patient use every two months.....	5-9
Figure 5-5	SLA battery capacity while installed in an AED for 3 months at 20° C (68° F) without recharging .....	5-11
Figure C-1	FAST-PATCH defibrillation cable for the LIFEPAK 500 AED.....	C-1
Figure C-2	Attaching lanyard.....	C-1
Figure C-3	Inserting defibrillation cable into AED .....	C-1
Figure C-4	Connecting to FAST-PATCH defibrillation/ECG electrodes.....	C-1
Figure C-5	Disconnecting from electrodes .....	C-2





## LIST OF TABLES

Table 2-1	Controls, Indicators, and Connectors .....	2-2
Table 2-2	Accessories for the LIFEPAK 500 AED.....	2-4
Table 2-3	Modem Phone Number Dial String Characters.....	2-7
Table 2-4	Modem Selection Numbers .....	2-8
Table 2-5	Setup Options and Default Settings.....	2-12
Table 4-1	LIFEPAK 500 AED Event Types .....	4-2
Table 4-2	LIFEPAK 500 AED Data and Retrieval.....	4-5
Table 4-3	Required Resources for Sending Data to a Computer by Modem.....	4-5
Table 4-4	Required Resources for Sending Data to a Computer by Direct Connection .....	4-8
Table 5-1	LIFEPAK 500 AED Inspection .....	5-2
Table 5-2	Recommended Cleaning Methods.....	5-4
Table 5-3	Supplies, Accessories, and Training Tools .....	5-14
Table 5-4	LIFEPAK 500 AED Specifications .....	5-15
Table 5-5	LIFEPAK 500 AED Battery Charger Specifications.....	5-19
Table 6-1	Troubleshooting During Patient Care .....	6-2
Table 6-2	Troubleshooting During Modem Data Transfer .....	6-4
Table 6-3	Troubleshooting During Setup Transfer.....	6-5
Table 6-4	LIFEPAK 500 AED Screen Messages.....	6-5
Table 6-5	LIFEPAK 500 AED Voice Prompts .....	6-7
Table A-1	LIFEPAK 500 AED SAS Performance Table for Adult ECGs .....	A-1
Table A-2	LIFEPAK 500 AED SAS Performance Table for Pediatric ECGs .....	A-2
Table D-1	Guidance and Manufacturer’s Declaration – Electromagnetic Emissions .....	D-3
Table D-2	Guidance and Manufacturer’s Declaration – Electromagnetic Immunity.....	D-4
Table D-3	Guidance and Manufacturer’s Declaration – Electromagnetic Immunity.....	D-5
Table D-4	Recommended Separation Distances .....	D-6



## PREFACE

About Defibrillation	page x
Operator Considerations	x
Indications for Use	xi
LIFEPAK 500 Automated External Defibrillator	xi
Features of the LIFEPAK 500 AED	xi

---

## ABOUT DEFIBRILLATION

Defibrillation is a recognized means of terminating certain potentially fatal arrhythmias. A direct current defibrillator applies a brief, high-energy pulse of electricity to the heart muscle. The LIFEPAK 500 Automated External Defibrillator (AED) delivers this energy through disposable defibrillation electrodes applied to the patient's chest.

Defibrillation is only one aspect of the medical care required to resuscitate a patient with a shockable ECG rhythm. Depending on the situation, other supportive measures may include:

- Cardiopulmonary resuscitation (CPR)
- Administration of supplemental oxygen
- Drug therapy

It is recognized that successful resuscitation is related to the length of time between the onset of a heart rhythm that does not circulate blood (ventricular fibrillation, pulseless ventricular tachycardia) and defibrillation. The American Heart Association has identified the following as critical links in the chain of survival from cardiac arrest:

- Early access
- Early CPR by first responders or bystanders
- Early defibrillation
- Early advanced life support

The physiological state of the patient may affect the likelihood of successful defibrillation. Thus, failure to resuscitate a patient is not a reliable indicator of defibrillator performance. Often, patients will exhibit a muscular response (such as jumping or twitching) during energy transfer. The absence of such a response is not a reliable indicator of actual energy delivery or device performance.

---

## OPERATOR CONSIDERATIONS

The LIFEPAK 500 AED is a semi-automatic defibrillator that uses a patented Shock Advisory System™. This software algorithm analyzes the patient's electrocardiographic (ECG) rhythm and indicates whether or not it detects a shockable rhythm. The LIFEPAK 500 AED requires operator interaction to defibrillate the patient.

The LIFEPAK 500 AED is intended for use by personnel who are authorized by a physician/medical director and have, at a minimum, the following skills and training:

- CPR training
- AED training equivalent to that recommended by the American Heart Association
- Training in the use of the LIFEPAK 500 AED

The LIFEPAK 500 AED is intended for use in the hospital and out-of-hospital environments. It has been tested to RTCA/DO-160D, "Environmental Conditions and Test Procedures for Airborne Equipment" (refer to *Specifications* on page 5-15).

---

## INDICATIONS FOR USE

The LIFEPAK 500 AED is to be used only on patients in cardiopulmonary arrest. The patient must be unconscious, not breathing normally, and showing no signs of circulation (for example, no pulse, and/or no coughing, no movement) before the device is used to analyze the patient's ECG rhythm. With Infant/Child Reduced Energy Defibrillation Electrodes, the specially configured biphasic LIFEPAK 500 AED may be used on children who are less than eight years old or who weigh less than 25 kg (55 lb).

---

## LIFEPAK 500 AUTOMATED EXTERNAL DEFIBRILLATOR

### LIFEPAK 500 AED, Biphasic

Yellow exterior with biphasic waveform.

### LIFEPAK 500 AED, Public Safety

Dark Gray exterior with biphasic waveform.

---

## FEATURES OF THE LIFEPAK 500 AED

The optional and configurable features of the LIFEPAK 500 AED are designed to meet a variety of protocol needs. Authorized operators of this AED should always use the AED in accordance with local protocols.

### Defibrillation Waveform

The LIFEPAK 500 AED is available with biphasic waveforms. For a description, refer to the Maintenance section.

### Defibrillation Electrodes

The LIFEPAK 500 AED uses disposable QUIK-COMBO™ pacing/defibrillation/ECG electrodes, with the REDI-PAK™ preconnect system, and FAST-PATCH® disposable defibrillation/ECG electrodes. The use of these electrodes allows rapid transfer of care to other devices that also use the same type of Medtronic electrodes.

Infant/Child Reduced Energy Defibrillation Electrodes can be used only with a biphasic LIFEPAK 500 AED that has been modified specifically to accept these electrodes. (Refer to Item 4, Cable Connector on page 2-3.) Infant/Child Reduced Energy Defibrillation Electrodes are not transferable to manual defibrillator/monitors and are not compatible with the QUIK-COMBO therapy cable.

### cprMAX™ Technology

The cprMAX technology is designed to allow resuscitation protocols to maximize the amount of CPR administered during treatment using the LIFEPAK 500 AED.

When used with the default settings, AED protocols are consistent with the 2005 American Heart Association (AHA) Guidelines for Cardiopulmonary Resuscitation and Emergency Cardiovascular Care and European Resuscitation Council (ERC) Guidelines for Resuscitation.

## Automated Operation

The operator controls AED operation with two or three top-panel buttons (**ON/OFF**, **ANALYZE** [optional], and **SHOCK**). For LIFEPAK 500 AEDs that do not have an **ANALYZE** button, the AED operates in **AUTO ANALYZE 2** mode (refer to page 2-9).

The AED guides the operator through operating procedures with a combination of:

- Voice prompts
- Tones
- Flashing LEDs
- Screen messages

The screen messages appear on a two-line liquid crystal display (LCD). Other LCD information includes:

- Real-time clock
- Cumulative shock counter
- Status and service messages
- CPR countdown timer

## Continuous Monitoring

The LIFEPAK 500 AED operates in two modes: ECG analysis and Continuous Patient Surveillance System (CPSS). During analysis, the AED indicates if it detects a shockable or nonshockable rhythm. The CPSS, which is active when the AED is not performing an analysis, automatically monitors for a potentially shockable rhythm.

## Motion Detection

The LIFEPAK 500 AED includes a patented system that detects motion. When motion that could distort the ECG rhythm occurs, analysis is temporarily inhibited.

## Data Management

The LIFEPAK 500 AED digitally records patient data, including ECG rhythm and delivered shocks. A digital audio recording of scene activity is available as an option. Recorded data may be transferred by direct connection to a computer or by a modem to a remote computer. Three optional, Microsoft® Windows®-compatible data management software programs are available.

## Battery Options

A rechargeable sealed lead-acid battery or one of two nonrechargeable lithium batteries (sulfur dioxide or manganese dioxide) provide power to the AED. The rechargeable battery requires periodic recharging by an external battery charger.

## Automatic Self-Test

The AED performs an automatic self-test every 24 hours and every time you turn on the AED. This feature tests the most important circuitry in the device to give the user a high degree of confidence that the AED is ready for use.

## Readiness Display

Most LIFEPAK 500 AEDs include a readiness display on the device's handle that can be seen at all times. **OK** displays if the automatic self-test is completed successfully. If the self-test detects that service is required or if the device detects that the battery needs immediate replacement, the **OK** indicator disappears and a service and/or battery indicator appear(s).

## Customized Setup

Operation can be customized for a LIFEPAK 500 AED with a readiness display by accessing a setup mode. Definable operating features include the modem phone number, the time interval allowed for CPR, and other features. Refer to *Changing Setup Options* on page 2-13 for more information about customized setup options.

Once you have customized the setup, the **TRANSFER SETUP** feature enables you to quickly transfer the setup to other LIFEPAK 500 AEDs. Refer to *Transferring Setup to Another LIFEPAK 500 AED* on page 2-16.

## Optional Accessories

Optional soft and hard carrying cases help to protect the AED and provide a pouch to store electrodes. Use the Medtronic LIFEPAK 500 AED Trainer to train operators to use the LIFEPAK 500 AED.





## SAFETY INFORMATION

This section provides important information to help you operate the LIFEPAK 500 Automated External Defibrillator (AED). Familiarize yourself with all of these terms, warnings, and symbols.

Terms	page 1-2
General Warnings and Cautions	1-2
Symbols	1-3

---

## **TERMS**

The following terms are used either in this manual or on the LIFEPAK 500 AED:

**Danger:** Immediate hazards that will result in serious personal injury or death.

**Warning:** Hazards or unsafe practices that could result in serious personal injury or death.

**Caution:** Hazards or unsafe practices that could result in minor personal injury, product damage, or property damage.

---

## **GENERAL WARNINGS AND CAUTIONS**

The following section provides general warning and caution statements. Other specific warnings and cautions are provided as needed in other sections of this manual.

### **WARNINGS!**

#### **Shock hazard.**

The defibrillator delivers up to 360 joules of electrical energy. Unless properly used as described in these Operating Instructions, this electrical energy may cause serious injury or death. Do not attempt to operate this device unless thoroughly familiar with these Operating Instructions, and the function of all controls, indicators, connections, and accessories.

#### **Shock hazard.**

Do not disassemble the defibrillator. It contains no operator serviceable components and dangerous high voltages may be present. Contact authorized service personnel for repair.

#### **Shock or fire hazard.**

Do not immerse any portion of this device in water or other fluids. Avoid spilling any fluids on device or accessories. Do not clean with ketones or other flammable agents. Do not autoclave or sterilize this device or accessories unless otherwise specified.

#### **Possible fire or explosion.**

Do not use this device in the presence of flammable gases or anesthetics. Use care when operating this device close to oxygen sources (such as bag-valve-mask devices or ventilator tubing). Turn off gas source or move source away from patient during defibrillation.

#### **Possible electrical interference with device performance.**

Equipment operating in close proximity may emit strong electromagnetic or radio frequency interference (RFI) which could affect the performance of this device. RFI may result in improper device operation, distorted ECG, failure to detect a shockable rhythm, or cessation of pacing. Avoid operating the device near cauterizers, diathermy equipment, cellular phones, or other portable and mobile RF communications equipment. Maintain equipment separation of at least 1.2 m (4 ft) and do not rapidly key EMS radios on and off. Contact a technical support representative if assistance is required.

#### **Possible electrical interference.**

Using cables, electrodes, or accessories not specified for use with this device may result in increased emissions or decreased resistance to electromagnetic interference which could affect the performance of this device or of equipment in close proximity. Use only parts and accessories specified in these operating instructions.

**WARNINGS!**

**Possible electrical interference.**

This defibrillator may cause electromagnetic interference (EMI) especially during charge and energy transfers. EMI may affect the performance of equipment operating in close proximity. Verify the effects of defibrillator discharge on other equipment prior to using defibrillator in an emergency situation, if possible.

**Possible device shutdown.**

Always have access to a spare, fully-charged, properly maintained battery. Replace the battery when the device displays a low battery warning.

**Possible improper device performance.**

Using other manufacturers' cables, electrodes, or batteries may cause the device to perform improperly and invalidates the safety agency certification. Use only the accessories specified in these Operating Instructions.

**Safety risk and possible equipment damage.**

Monitors, defibrillators, and their accessories (including electrodes and cables) contain ferromagnetic materials. As with all ferromagnetic equipment, these products must not be used in the presence of the high magnetic field created by a Magnetic Resonance Imaging (MRI) device. The high magnetic field created by an MRI device will attract the equipment with a force sufficient to cause death or serious personal injury to persons between the equipment and the MRI device. This magnetic attraction may also damage the equipment. Skin burns will also occur due to heating of electrically conductive materials, such as patient leads and pulse oximeter sensors. Consult the MRI manufacturer for more information.

**Shock hazard.**

Do not insert a hand, foot, or any object other than a battery into the battery well of this device.

**CAUTION!**

**Possible equipment damage.**

This device may be damaged by mechanical or physical abuse such as immersion in water or dropping the device. If the device has been abused, remove it from use and contact a qualified service technician.

**SYMBOLS**

The symbols below may be found in this manual or on various configurations of the LIFEPAK 500 AED and accessories:



Defibrillation protected, type BF patient connection





Attention, consult accompanying documents



Warning, high voltage

## Safety Information

- 

Indicator, steady display indicates battery is low, replace battery; flashing (key panel only) indicates replace battery immediately
- 

Indicator, steady display indicates device requires service; flashing (key panel only) indicates service is required immediately
- OK**

Indicator, appears on the readiness display indicating the self-test completed successfully
- 

Buttons for setting the clock, transferring data, and setting options
- 

Type BF patient connection
- 

Rechargeable battery: recycle battery
- 

Do not dispose of this product in the unsorted municipal waste stream. Dispose of this product according to local regulations. See <http://recycling.medtronic.com> for instructions on disposing of this product.
- 

Battery Charger: green LED indicates power is on
- 

Battery Charger: battery is charging; amber LED indicates fast charge, green LED indicates trickle charge
- 

Indoor use only
- 

Safety Class II equipment (reinforced insulation)
- 

Setup transfer cable
- LOT** yyww

Lot number (batch code)
- 

Use By date shown: yyyy-mm-dd or yyyy-mm
- 

Single use only
- 

Mark of conformity according to the European Medical Device Directive 93/42/EEC
- 

Canadian Standards Association certification for Canada and the United States
- 

Cable Connector



Biphasic defibrillation shock

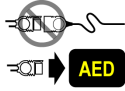

The Infant/Child Reduced Energy Defibrillation Electrodes are not compatible with QUIK-COMBO defibrillation and therapy cables. To use Infant/Child electrodes, connect Infant/Child electrodes directly to the AED.



For USA audiences only



Protect from water.



Not intended for use on children who are less than eight years of age or who weigh less than 25 kg (55 pounds).



Not intended for use on adults.



Medtronic Emergency Response systems electrodes are latex-free.



Date of manufacture.



Power On/Off.



Power On/Off.



Shock button.



Fragile/breakable.  
Handle with care.

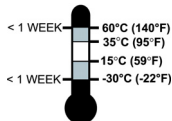

Recommended storage temperature: 15° to 35°C (59° to 95°F). Storage at extreme temperatures of -30° and 60°C (-22° and 140°F) is limited to seven days. If storage at these temperatures exceeds one week, the electrode shelf-life will be reduced.

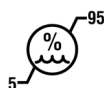

Relative humidity range 5% to 95%.

## Safety Information



Not for clinical use.



This end up.

REF Reorder number (same as CAT.)  
MIN Manufacturer's item number  
CAT. Catalog number used for placing orders

---

## GETTING READY

This section provides a basic orientation to the LIFEPAK 500 Automated External Defibrillator (AED) and describes how to prepare the AED for use.

Unpacking and Initial Inspection	page 2-2
Controls, Indicators, and Connectors	2-2
About Batteries	2-5
Setting the Clock	2-6
Defining Setup Options	2-7
Default Settings	2-12
Changing Setup Options	2-13
Transferring Setup to Another LIFEPAK 500 AED	2-16
Connecting Electrodes to the AED	2-17



## UNPACKING AND INITIAL INSPECTION

Remove the LIFEPAK 500 AED from the shipping container. Examine the AED and accessories for any sign of damage during shipping. Make sure that all the required supplies and accessories, including electrodes and batteries, are present. Save the shipping container and foam inserts for use in reshipping the AED.

## CONTROLS, INDICATORS, AND CONNECTORS

Figure 2-1 and Table 2-1 provide an overview of the LIFEPAK 500 AED controls, indicators, and connectors. Figure 2-2 and Table 2-2 provide an overview of the accessories.

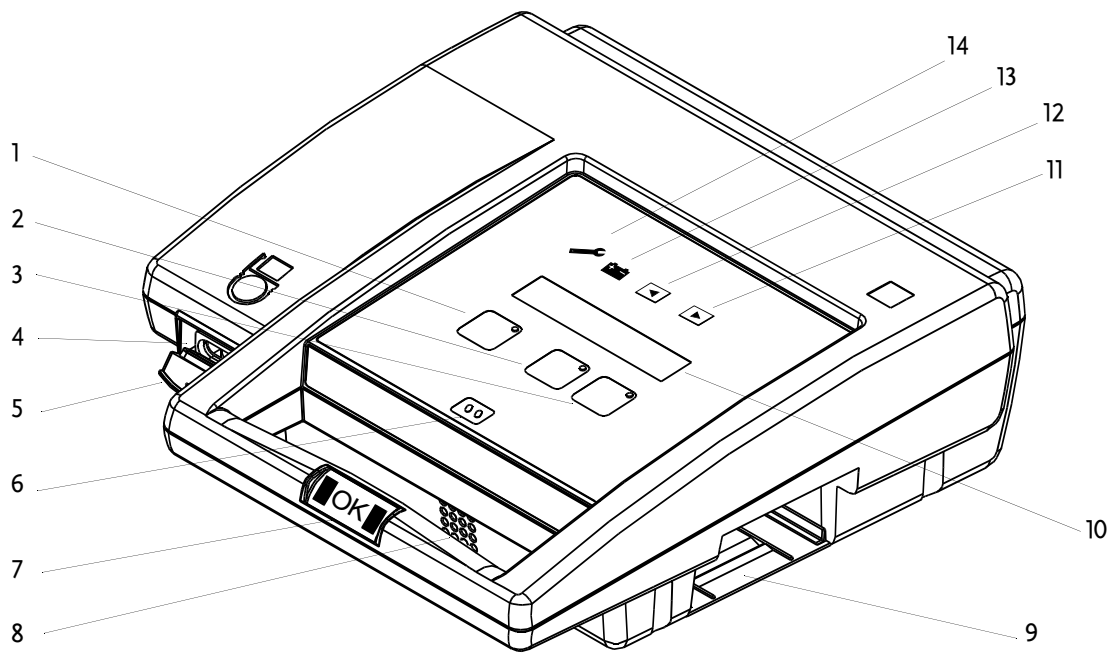

Figure 2-1 LIFEPAK 500 AED controls, indicators, and connectors

Table 2-1 Controls, Indicators, and Connectors







1		<p>Green <b>ON/OFF</b> button turns the power on or off. The LED is lit whenever the AED is on.</p>
2		<p>Yellow <b>ANALYZE</b> button initiates analysis of the patient's ECG rhythm when pressed. The LED is lit while the AED analyzes the rhythm. The LED flashes to prompt the operator to press <b>ANALYZE</b>.</p> <p><b>Note:</b> Does not apply to LIFEPAK 500 AEDs that do not have an <b>ANALYZE</b> button. In this case, the <b>ANALYZE</b> button is replaced by a blank <b>MENU</b> button, and analysis occurs automatically.</p>

Table 2-1 Controls, Indicators, and Connectors (Continued)

3		Orange <b>SHOCK</b> button delivers energy. The LED flashes to prompt the operator to press <b>SHOCK</b> when the AED is fully charged.
4	Cable Connector Receptacle	Allows connection to the following: <ul style="list-style-type: none"> <li>• QUIK-COMBO electrodes (REDI-PAK)</li> <li>• Cables for connection to a computer, modem, another LIFEPAK 500 AED, or FAST-PATCH electrodes</li> <li>• Test load for testing</li> <li>• Patient Simulator</li> </ul> If the cable connector has a pink-colored center, Infant/Child Reduced Energy Defibrillation Electrodes can be used with the AED by connecting the electrodes directly to the cable connector receptacle.
5	Connector Cover	Protects cable connector.
6	Microphone	Allows input for audio recording.
7	Readiness Display	Displays <b>OK</b> when the automatic self-test is completed successfully. If the self-test detects that service is required or if the device detects that the battery needs immediate replacement, the <b>OK</b> indicator disappears and a service and/or battery indicator appear(s).
8	Speaker	Provides audio voice prompts and tones.
9	Battery Compartment	Accommodates a single removable battery pak that provides power for the AED.
10	Liquid Crystal Display (LCD)	Provides operating messages on two 20-character lines.*
11	 Right arrow button	Used to set the clock, transfer data, and set options.
12	 Up arrow button	Used to set the clock, transfer data, and set options.
13	 Low battery indicator	Steady display indicates the AED battery is low; flashing, on key panel only, indicates replace battery immediately.
14	 Service indicator	Steady display indicates the AED requires service by authorized service personnel; flashing indicates service is required immediately.

\* Accent marks are not included in operating messages for international languages.

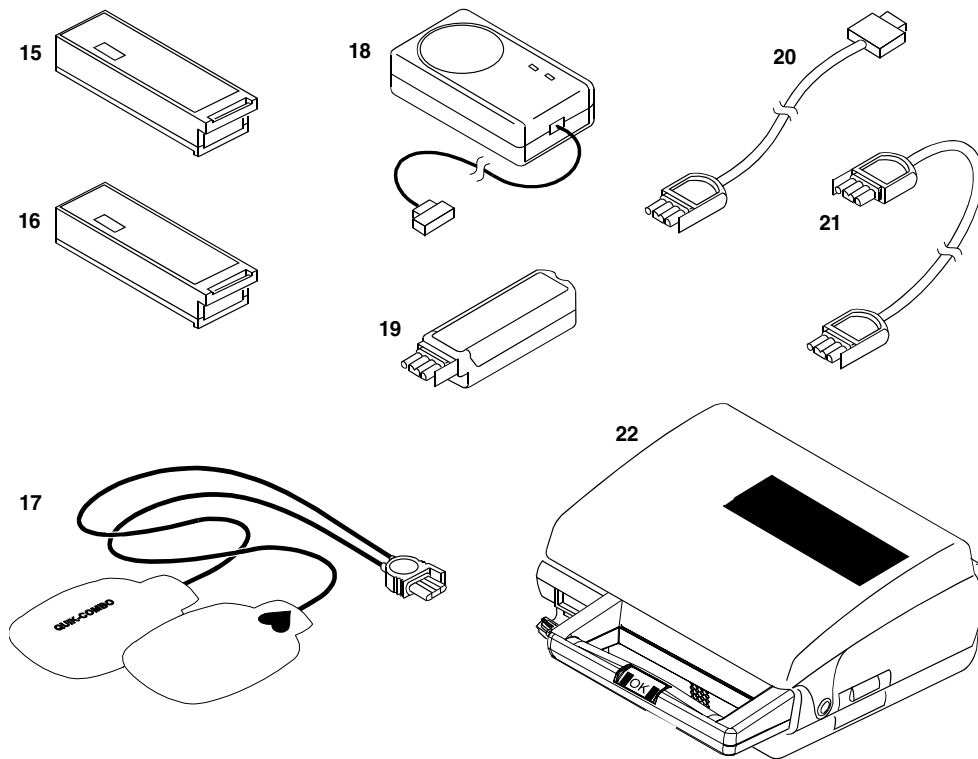

Figure 2-2 Accessories for the LIFEPAK 500 AED

Table 2-2 Accessories for the LIFEPAK 500 AED

15	LIFEPAK 500 nonrechargeable lithium battery pak	Provides power for the LIFEPAK 500 AED.
16	LIFEPAK 500 rechargeable SLA battery pak	Provides power for the LIFEPAK 500 AED. The SLA (Sealed Lead-Acid) battery pak is recharged by the battery charger listed in 18.
17	QUIK-COMBO electrodes	Allow delivery of therapy to the patient. Connect to the cable connector on the AED or to the QUIK-COMBO defibrillation cable (refer to Appendix D).
18	Battery charger	Provides power to recharge the rechargeable SLA battery pak.
19	Test load	Provides an external test load for the AED. Connects to the cable connector on the AED.
20	Data cable	One of three available cables shown. Allows transfer of data from AED to PC or modem. Plugs into the cable connector on the AED. Cables are 3-wire cables.
21	Setup Transfer Cable	Allows transfer of customized device setup from one LIFEPAK 500 AED to another.
22	Carrying cases	Hard and soft carrying cases available. Cases help protect the AED and provide storage for electrodes.

## ABOUT BATTERIES

Use any of the following battery types to power the LIFEPAK 500 AED:

- LIFEPAK 500 rechargeable sealed lead-acid (SLA) battery pak
- LIFEPAK 500 nonrechargeable lithium sulfur dioxide (LiSO<sub>2</sub>) battery pak
- LIFEPAK 500 nonrechargeable lithium manganese dioxide (LiMnO<sub>2</sub>) battery pak

To save battery life if the LIFEPAK 500 AED is accidentally turned on or left on, the AED has a battery conservation feature. If the AED is not connected to a patient and no buttons are pressed for 15 minutes, the AED will automatically turn off.

With a battery installed, the LIFEPAK 500 AED automatically performs daily auto tests when the AED is not in use. These auto tests, along with normal battery self-discharge, consume battery energy.

For information about maintaining or recharging the batteries, refer to page 5-7.

## Battery Installation

### WARNING!

Inability to provide therapy.

The LIFEPAK 500 nonrechargeable lithium manganese dioxide battery pak **does not fit** in all LIFEPAK 500 AEDs. Use only with AEDs marked -003 inside the battery well.

To install a battery:

- 1 Insert the connector end of the battery into the battery compartment as shown in Figure 2-3.
- 2 Slide the battery all the way in until it latches securely.

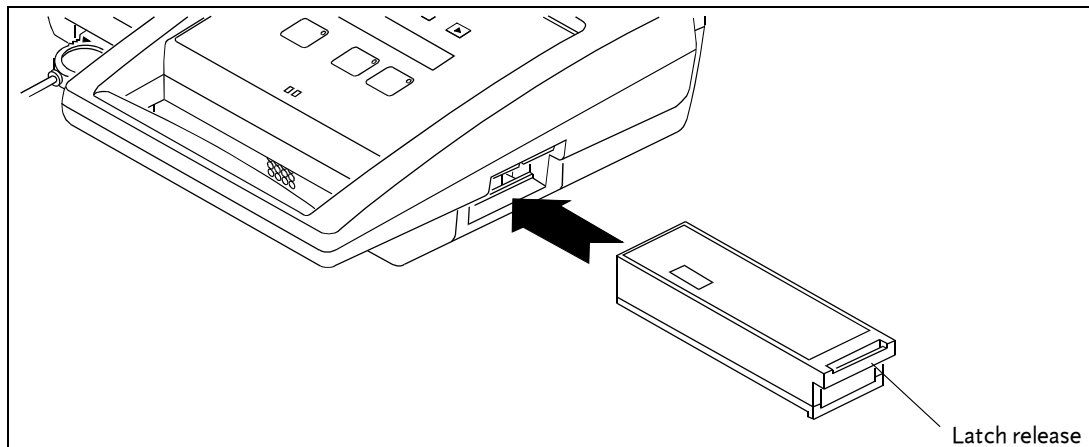

Figure 2-3 Battery installation

## Battery Removal

To remove the battery:

- 1 Turn off the AED.
- 2 Lift the latch release on the battery and slide it out.

**Note:** When a battery is removed from the AED, battery and service indicators appear on the readiness display. After replacing the battery, turn on the device to reset the readiness display.

## Low Battery Detection

Whenever the LIFEPAK 500 AED is turned on after it has been off for at least 60 seconds, it takes about 10 seconds to complete a self-test and to indicate a low or replace battery condition.

The AED monitors the battery power level and indicates when the battery should be replaced:



Indicator illuminates on the device key panel and appears on the readiness display and the **LOW BATTERY** message displays on the LCD; battery is low.

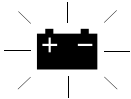

Indicator flashes on and off on the device key panel, the **REPLACE BATTERY** message displays, and a voice prompt sounds; battery is low and should be replaced immediately.

**Note:** The readiness display battery indicator does not flash.

When the battery power is too low, the AED will automatically turn off. The service and battery indicators appear on the readiness display.

If the **AUDIO ALERT** option is set to **ON** and the AED detects a low or replace battery condition during an automatic self-test while it is not in use, audible beeps and the **REPLACE BATTERY** voice prompt sounds. The **AUDIO ALERT** will repeat every 20 minutes until the battery is replaced or battery power becomes too low to power the AED.

---

## SETTING THE CLOCK

You may set the clock at any time except during the interval between patient care and data transfer to a computer or printer. Setting the clock during this interval will interfere with proper time synchronization.

To change the date and time:

- 1 Turn on the AED. (Be sure the AED has been off for at least 60 seconds and that nothing is connected to the AED.)
- 2 Press and hold the ▲ or ► button for approximately three seconds until the AED displays the date and time setting:

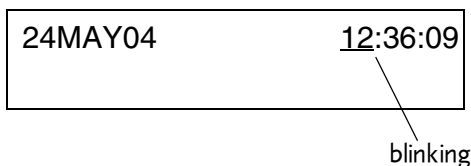

A value blinking on and off indicates that the value can be changed. The day, month, year, hour, and minutes values can be increased. The seconds value can be reset to zero.

- 3 To set the hour:
  - Press the ▲ button to increase the value.
  - Press the ► button to advance to the next field.
- 4 To set the minutes:
  - Press the ▲ button to increase the value.
  - Press the ► button to advance to the next field.

- 5 To reset the seconds value to zero:
  - Press the ▲ button once.

**Note:** If the seconds value is less than 30 when reset, the minutes value stays the same. If the seconds value is greater than 30 seconds when reset, the minutes value increases by one.

  - Press the ► button to advance to the next field.
- 6 Repeat Step 3 as needed to set the day, month, and year.
- 7 After the date and time are set, press **ON/OFF** to turn off the AED.

## DEFINING SETUP OPTIONS

The following paragraphs describe the setup options that define some of the operating features for the LIFEPAK 500 AED. The user should become thoroughly familiar with the operating features particular to their LIFEPAK 500 AED.

### Device ID

The **DEVICE ID** option assigns a unique identifier that is printed at the top of each report. Up to 20 characters with any combination of displayable characters can be used. The factory default setting is an automatically generated sequence number.

### Modem Phone Number

The **MODEM PHONE NUMBER** option is the character string that the AED dials when it transfers data by modem. The dial string may include up to 20 characters as described in Table 2-3. The default dial string is T9W18886279698. This is the dial string required to download data from the LIFEPAK 500 AED to Medtronic ERS. The characters T9W are required if 9 must be dialed first to access an outside line from the telephone being used. However, if the telephone being used has direct access (long distance dialing begins with 1), change T9W to blanks.

Table 2-3 Modem Phone Number Dial String Characters

Character	Description
P	Selects pulse dialing (only allowed as first character)
T	Selects tone dialing (only allowed as first character)
,	Inserts 2-second pause in dialing string
\$	Waits for "bong" (calling card) tone
W	Waits for second dial tone
Alphanumeric characters	A, B, C, D and 0 through 9 (no special function)
* # ( )	Other characters (no special function)
+	Terminates dial string

### Modem Selection

The **MODEM SELECTION** option determines the initialization string for the modems listed in Table 2-4. Select the number that matches your modem. If you select 0, you must define the modem initialization string in the next option (**MODEM INIT STRING**). The default setting is 5.

Table 2-4 Modem Selection Numbers

Number	Modem Type
0	No modem selected*
1	Hayes™ ACCURA™ 288 External Fax Modem Hayes ACCURA 336 External Fax Modem
2	U. S. Robotics® Sportster® 28.8 Modem U. S. Robotics Sportster 33.6 Modem
3	Motorola Lifestyle 28.8 Data/Fax Modem
4	SupraExpress 33.6 Fax Modem Hayes ACCURA 144 External Fax Modem Hayes ACCURA 56K External Fax Modem Hayes ACCURA 336 External Fax Modem with Voice Hayes ACCURA 336 External Fax Modem with Simultaneous Voice and Data Hayes ACCURA 56K Speakerphone Modem
5	U. S. Robotics Courier V.Everything U. S. Robotics 56K Fax Modem (Sportster)

\* You must specify the modem initialization string in the **MODEM INIT STRING** option.

The selection of commercially available modems changes rapidly. For more information or assistance regarding compatible modems, contact Medtronic Technical Support. In the USA call 1.800.442.1142. Outside the USA, contact your local Medtronic representative.

### Modem Initialization String

The **MODEM INIT STRING** option defines the modem initialization string for a Hayes-compatible modem (TIA/EIA-602). Up to 75 characters with any combination of displayable characters can be used. The default string is blank.

**Note:** The AED does not display **MODEM INIT STRING** unless the **MODEM SELECTION** is set to 0.

### Energy Sequence

The **ENERGY SEQUENCE** option defines the three possible energy levels used by the LIFEPAK 500 AED.

For the LIFEPAK 500 AED with the biphasic defibrillation waveform, the available energy levels for 1, 2, and 3 are: 150, 175, 200, 225, 250, 275, 300, 325, and 360 joules.

**Note:** Energy levels of 150 and 175 joules may not be available in some countries.

The default settings are:

- Energy level 1 – 200 joules
- Energy level 2 – 300 joules
- Energy level 3 – 360 joules

### Energy Protocol

The **ENERGY PROTOCOL** option determines either a fixed or flexible sequence for your energy protocol. The default setting is **FLEXIBLE SEQUENCE**.

Flexible sequence means the energy delivered for a shock increments only if an analysis immediately following a shock results in a **SHOCK ADVISED** decision. For example, if the AED energy sequence is set up as 200, 300, 360, flexible sequence means that the energy delivered for the first shock is 200 joules. If the arrhythmia is terminated by shock 1 and the next analysis results in a **NO SHOCK ADVISED** decision, the energy will **not** increase for the next shock. However, if the arrhythmia is not terminated by shock 1 and the next analysis results in a **SHOCK ADVISED** decision, the energy will increase to 300 joules.

Fixed sequence means that the energy delivered after the first shock of 200 joules increments from 200 to 300, and then to 360 joules, regardless of the post-shock ECG rhythm and subsequent analysis decision.

## Display Energy

The **DISPLAY ENERGY** option determines whether or not the energy of the last shock is displayed during use. The default setting is **ON**.

## Auto Analyze

The **AUTO ANALYZE** options are **OFF**, **1**, and **2**.

**AUTO ANALYZE OFF:** The operator must press **ANALYZE** to start every analysis.

**AUTO ANALYZE 1:** The second and third rhythm analyses of each three-shock set start automatically without requiring the operator to press **ANALYZE**. (The operator must always press **ANALYZE** to start the first analysis of a three-shock set and to analyze after a **NO SHOCK ADVISED** message or CPR cycle.) The default setting is **AUTO ANALYZE 1**.

**AUTO ANALYZE 2:** All analysis cycles are initiated automatically. LIFEPAK 500 AEDs that do not have an **ANALYZE** button operate in this mode.

## Stack Shocks

When set to **OFF**, the **STACK SHOCKS** option inserts prompting for CPR after each (a single) shock. This eliminates the three-shock stack. CPR is prompted after the shock regardless of the ECG rhythm. The CPR time following the shock is determined by the **CPR TIME 1** setting selected. Choices for the **STACK SHOCKS** option are **ON** or **OFF**. The default setting is **OFF**.

With this option is set to **ON**, the defibrillator follows the previously traditional stacked shock protocol and delivers up to three consecutive shocks, as necessary, without interposed CPR.

## Initial CPR

The **INITIAL CPR** option prompts the user to perform an initial period of CPR. The choices are: **CPR FIRST**, **ANALYZE FIRST**, and **OFF**. The default setting is **OFF**.

- The **CPR FIRST** setting prompts the user to perform CPR immediately after the defibrillator is powered on. The AED will also prompt, **IF YOU WITNESSED THE ARREST, PUSH ► (RIGHT ARROW)**, which provides the opportunity to end CPR early and proceed directly to analysis.
- The **ANALYZE FIRST** setting prompts for analysis and then CPR. If the analysis determines that a shock is needed, the AED will prompt, **IF YOU WITNESSED THE ARREST, PUSH ►**, which provides the opportunity to end CPR early and proceed directly to delivering a shock.
- The **OFF** setting has no prompting for an initial CPR period.

Refer to *Special Setup Options* on page 3–8 for a more detailed description of the AED prompting sequence for each **INITIAL CPR** option.



Medical directors who choose to implement this option should develop a protocol and provide training to responders instructing them when to end the initial CPR interval early. Potential situations for instructing responders to end CPR early include:

- The patient's collapse was witnessed by the responder.
- The responder ascertains that fewer than four or five minutes have elapsed since the patient's collapse.
- The patient exhibits agonal breathing, an indicator of a short downtime.
- The responder ascertains that CPR of adequate quality and duration has already been provided by bystanders before attaching the AED electrodes.

### Initial CPR Time

The **INITIAL CPR TIME** option applies when **INITIAL CPR** is set to **ANALYZE FIRST** or **CPR FIRST**. It sets the CPR time for that CPR period. The time choices for **INITIAL CPR TIME** are: 15, 30, 45, 60, 90, 120, and 180 seconds. The default setting is 120 seconds.

### Pre-Shock CPR Time

The **PRE-SHOCK CPR TIME** option inserts prompting for CPR when a shockable ECG rhythm is detected and during the time the AED is charging. It applies only when analysis results in **SHOCK ADVISED** decisions. When **INITIAL CPR** is set to **OFF** or **CPR FIRST**, **PRE-SHOCK CPR TIME** applies to the first and all subsequent shocks. When **INITIAL CPR** is set to **ANALYZE FIRST**, **PRE-SHOCK CPR TIME** applies to the second and all subsequent shocks. The choices for **PRE-SHOCK CPR TIME** are: **OFF**, 15, and 30 seconds. To prompt for CPR only for the time the capacitor is charging, select the 15-second CPR interval. The **SHOCK** button is not enabled until charging and CPR time are completed. The default setting for **PRE-SHOCK CPR TIME** is **OFF**.

**Note:** Although the **SHOCK** button is disabled during the pre-shock CPR interval, it becomes active as soon as the pre-shock CPR interval ends. To minimize the interval between the final chest compression and shock delivery (while maintaining responder safety), medical directors who select this option should provide specific training and protocols to address the rapid transition from pre-shock CPR to shock delivery.

### CPR Times 1 and 2

- The **CPR TIME 1** option inserts prompting to perform CPR after a single shock (**STACK SHOCKS OFF**) or set of three shocks (**STACK SHOCKS ON**) is delivered.
- The **CPR TIME 2** option inserts prompting to perform CPR after a **NO SHOCK ADVISED** decision.

The choices for both CPR Times 1 and 2 are: 0, 15, 30, 45, 60, 90, 120, and 180 seconds, and 999 (infinite CPR time). For all selections except 0 and 999, the AED prompts you to perform CPR and then displays a countdown timer. If 999 is selected, the AED prompts you to perform CPR but does not display the countdown timer. The AED will not prompt you to **PUSH ANALYZE** (for AEDs with an **ANALYZE** button), although you may do so at any time to initiate an analysis. The default setting for both CPR Times 1 and 2 is 120 seconds (two minutes).

**Note:** When an analysis after a shock results in a **NO SHOCK ADVISED** message, the CPR period is the same as **CPR TIME 1**.

**Note:** **CPR TIME 0** is not available if **AUTO ANALYZE 2** is selected on AEDs that have an **ANALYZE** button or on AEDs that do not have an **ANALYZE** button. **CPR TIME 999** is not available on AEDs that do not have an **ANALYZE** button.

## Pulse Check

The **PULSE CHECK** option inserts prompting to check for a pulse or check the patient, depending on the **PULSE PROMPT** setting (refer to next section). The choices for **PULSE CHECK** are: **NEVER**, **AFTER SECOND NSA**, **AFTER EVERY NSA**, and **ALWAYS**. The default setting is **NEVER**.

- **AFTER SECOND NSA** prompts for a pulse check after the second analysis if the second analysis results in a **NO SHOCK ADVISED** decision, regardless of the first analysis decision (**SHOCK ADVISED** or **NO SHOCK ADVISED**).
- **AFTER EVERY NSA** prompts for a pulse check after every **NO SHOCK ADVISED** decision.
- **ALWAYS** prompts for a pulse check after CPR Times 1 and 2, after a **NO SHOCK ADVISED** decision, after a single **SHOCK ADVISED** decision with **STACK SHOCKS OFF**, or after three consecutive **SHOCK ADVISED** decisions if **STACK SHOCKS** is **ON**.
- **NEVER** eliminates all **PULSE CHECK** prompts.

## Pulse Prompt

The **PULSE PROMPT** option determines which voice and text messages will be used when **PULSE CHECK** is enabled. The choices are **PULSE PROMPT 1** and **PULSE PROMPT 2**. The default setting is **PULSE PROMPT 1**.

- **PULSE PROMPT 1** provides the following voice and text messages: **CHECK FOR PULSE; IF NO PULSE, START CPR** and **CHECK FOR PULSE; IF NO PULSE, PUSH ANALYZE**.
- **PULSE PROMPT 2** provides the following voice and text messages: **CHECK PATIENT; IF NOT MOVING AND NOT BREATHING NORMALLY, START CPR** and **CHECK PATIENT; IF NOT MOVING AND NOT BREATHING NORMALLY, PUSH ANALYZE**.

**Note:** The **CHECK PATIENT** messages appear on AEDs distributed in the English (U.S.), Portuguese (Brazil), Mandarin, Hebrew, Arabic, Japanese, and Korean languages. In other countries, **PULSE PROMPT 2** may be replaced with: **CHECK FOR SIGNS OF CIRCULATION; IF NO SIGNS OF CIRCULATION, START CPR** and **CHECK FOR SIGNS OF CIRCULATION; IF NO SIGNS OF CIRCULATION, PUSH ANALYZE**.

## Motion Detection

The **MOTION DETECTION** option determines whether or not the motion detection system is active during analysis. When this option is **ON** and motion is detected, a warning is given and analysis is prevented for up to 10 seconds. After 10 seconds, analysis continues regardless of whether or not motion is present. For more information about motion detection and factors relevant to selecting **ON** or **OFF**, refer to Appendix A. The default setting for **MOTION DETECTION** is **ON**.

## Asystole Detector

This option enables the **ASYSTOLE DETECTOR**. When active, the **ASYSTOLE DETECTOR** notifies the user that asystole has been detected for a number of consecutive analyses over a period of time. The time interval determines how long asystole must be detected before the **ASYSTOLE** message appears. The time intervals that can be selected are from 4 to 60 minutes (in one-minute intervals). The default setting is **OFF**.

## Audio Recording

**AUDIO RECORDING** is only displayed if the option is installed. The **AUDIO RECORDING** option may be **ON** or **OFF**. If it is **ON**, the AED records the audio during patient care. If it is **OFF**, the AED does not record the audio. The default setting is **ON**.

## Incident ID

An **INCIDENT ID** number can be entered prior to transferring patient data to a computer through a modem. You can use up to 20 characters with any combination of displayable characters. The default setting is **OFF**.

## Audio Alert

The **AUDIO ALERT** option determines whether or not an audible tone (beeps) sounds when the automatic self-test detects a low battery condition or a condition that requires service. The default setting is **OFF**. Regardless of whether the **AUDIO ALERT** is set to **ON** or **OFF**, indicators appear on the readiness display if a low battery or service condition is detected.

The **AUDIO ALERT** option is only available on AEDs with a readiness display distributed in the English language.

## Transfer Setup

Once the setup in one LIFEPAK 500 AED has been customized, the **TRANSFER SETUP** option supports the transfer of this setup to other LIFEPAK 500 AEDs. Setup transfers are possible only between LIFEPAK 500 AEDs with the same button configuration (for example, 2-button to 2-button) and defibrillation waveform.

---

## DEFAULT SETTINGS

Default settings for setup options are summarized in the following table.

Table 2-5 Setup Options and Default Settings

Setup Options	Default Settings
Device ID	Automatically generated sequence number
Modem Phone Number	T9W1886279698
Modem Selection	5
Modem Initialization String	blank
Energy Sequence	200–300–360 joules
Energy Protocol	FLEXIBLE SEQUENCE
Display Energy	ON
Auto Analyze	1
Stack Shocks*	OFF
Initial CPR*	OFF
Initial CPR Time	120 seconds
Pre-Shock CPR Time*	OFF
CPR Time 1*	120 seconds
CPR Time 2*	120 seconds
Pulse Check*	NEVER
Pulse Prompt	1
Motion Detection	ON
Asystole Detector	OFF

Table 2-5 Setup Options and Default Settings (Continued)

Setup Options	Default Settings
Audio Recording	ON
Incident ID	OFF
Audio Alert	OFF

\* When cprMAX technology setup option default settings are used, AED protocols are consistent with 2005 AHA and ERC Guidelines.

### CHANGING SETUP OPTIONS

To change the setup options:

- 1 Make sure the LIFEPAK 500 AED power is off for at least 60 seconds and that nothing is connected to the AED.
- 2 If the LIFEPAK 500 AED has an **ANALYZE** button, hold down the **ANALYZE**, **▲**, and **▶** buttons. Then, press **ON/OFF**. Do not release **ANALYZE**, **▲**, and **▶** until the **SETUP MODE** message appears.  
If the LIFEPAK 500 AED does NOT have an **ANALYZE** button, hold down the blank "menu" button (located between the **ON/OFF** and **SHOCK** buttons), **▲**, and **▶** buttons. Then press **ON/OFF**. Do not release the blank "menu" button, **▲**, and **▶** until the **SETUP MODE** message appears.
- 3 Notice that the AED displays the **SETUP MODE** screen.

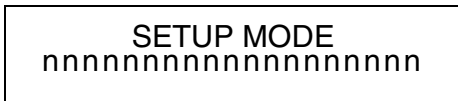

The nnnnnnnnnnnnnnnnnnn is the configuration code. This code, which appears at the top of each printed report, summarizes some of the setup and service settings.

- 4 Press **ANALYZE** (or blank "menu" button) to advance to the **DEVICE ID** screen.

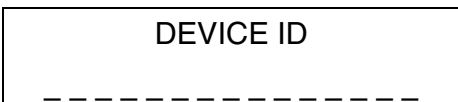

- Press the **▲** button to change the character (choices are 0-9, A-Z, # - . , and space characters).
- Press the **▶** button to advance to the next space.

- 5 Press **ANALYZE** (or blank "menu" button) to advance to the **MODEM PHONE NUMBER** screen.

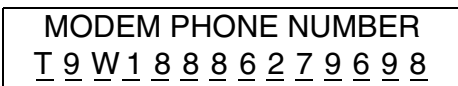

- Press the **▲** button to change the character. The characters available are: ( ) \* , - 0 through 9 PTW#\$.
- Press the **▶** button to advance to the next character location (20 characters maximum).

- 6 Press **ANALYZE** (or blank "menu" button) to advance to the **MODEM SELECTION** screen.

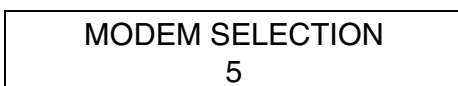

- Press the **▲** button to change the modem selection (select 0, 1, 2, 3, 4, and 5).

- 7 Press **ANALYZE** (or blank "menu" button) to advance to the **MODEM INIT STRING** screen if the **MODEM SELECTION** is 0 (or advance to the **ENERGY SEQUENCE** screen if the **MODEM SELECTION** is 1, 2, 3, 4, and 5).

MODEM INIT STRING  
-----

- Press the ▲ button to change the character (choices are all displayable characters).
- Press the ► button to advance to the next character location (75 characters maximum).

Call your Medtronic service representative for assistance with defining the correct initialization string.

- 8 Press **ANALYZE** (or blank "menu" button) to advance to the **ENERGY SEQUENCE** screen.

ENERGY SEQUENCE  
#1-200 #2-300 #3-360

A value blinking on and off indicates that value can be changed.

- Press the ▲ button to change the energy selection. Your choices are: 150, 175, 200, 225, 250, 275, 300, 325, and 360 joules. Pressing ▲ after the highest energy setting will display the lowest possible energy setting.

**Note:** **ENERGY SEQUENCE #2** cannot be set lower than **ENERGY SEQUENCE #1**.  
**ENERGY SEQUENCE #3** cannot be set lower than **ENERGY SEQUENCE #2**.

- Press the ► button to advance to the next energy level.

- 9 Press **ANALYZE** (or blank "menu" button) to advance to the **STACK SHOCKS** screen.

STACK SHOCKS  
OFF

- Press the ▲ button to change the setting (choices are **ON** and **OFF**).

- 10 Press **ANALYZE** (or blank "menu" button) to advance to the **ENERGY PROTOCOL** screen.

ENERGY PROTOCOL  
FLEXIBLE SEQUENCE

- Press the ▲ button to change the setting (choices are **FIXED SEQUENCE** and **FLEXIBLE SEQUENCE**).

- 11 Press **ANALYZE** (or blank "menu" button) to advance to the **DISPLAY ENERGY** screen.

DISPLAY ENERGY  
ON

- Press the ▲ button to change the setting (choices are **ON** and **OFF**).

- 12 If the LIFEPAK 500 AED has an **ANALYZE** button, press **ANALYZE** to advance to the **AUTO ANALYZE** screen.

AUTO ANALYZE  
1

- Press the ▲ button to change the setting (choices are **OFF**, 1, and 2).

If the LIFEPAK 500 AED does not have an **ANALYZE** button, the **AUTO ANALYZE** screen will not display.

13 Press **ANALYZE** (or blank "menu" button) to advance to the **INITIAL CPR** screen.

INITIAL CPR  
OFF

- Press the ▲ button to change the setting (choices are **CPR FIRST**, **OFF**, and **ANALYZE FIRST**).

14 Press **ANALYZE** (or blank "menu" button) to advance to the **INITIAL CPR TIME** screen.

INITIAL CPR TIME  
120

- Press the ▲ button to change the setting (choices are **15**, **30**, **45**, **60**, **90**, **120**, and **180** seconds).

15 Press **ANALYZE** (or blank "menu" button) to advance to the **PRE-SHOCK CPR TIME** screen.

PRE-SHOCK CPR TIME  
OFF

- Press the ▲ button to change the setting (choices are **OFF** and **15** or **30** seconds).

16 Press **ANALYZE** (or blank "menu" button) to advance to the **CPR TIME 1** screen.

CPR TIME 1  
120 SEC

- Press the ▲ button to change the setting (choices are **0**, **15**, **30**, **45**, **60**, **90**, **120**, **180**, and **999**).

17 Press **ANALYZE** (or blank "menu" button) to advance to the **CPR TIME 2** screen.

CPR TIME 2  
120 SEC

- Press the ▲ button to change the setting (choices are **0**, **15**, **30**, **45**, **60**, **90**, **120**, **180**, and **999**).

18 Press **ANALYZE** (or blank "menu" button) to advance to the **PULSE CHECK** screen.

PULSE CHECK  
NEVER

- Press the ▲ button to change the setting (choices are **NEVER**, **AFTER SECOND NSA**, **AFTER EVERY NSA**, and **ALWAYS**).

19 Press **ANALYZE** (or blank "menu" button) to advance to the **PULSE PROMPT** screen.

PULSE PROMPT  
1

- Press the ▲ button to change the setting (choices are **1** and **2**).

20 Press **ANALYZE** (or blank "menu" button) to advance to the **MOTION DETECTION** screen.

MOTION DETECTION  
ON

- Press the ▲ button to change the setting (choices are **ON** and **OFF**).

21 Press **ANALYZE** (or blank "menu" button) to advance to the **ASYSTOLE DETECTOR** screen.

ASYSTOLE DETECTOR  
OFF

- Press the ▲ button to change the setting (choices are **OFF** and 4 to 60 minutes in one-minute increments).

**Note:** Pressing ▲ after the highest setting will display **OFF**.

22 If the LIFEPAK 500 AED is equipped with the audio recording capability, press **ANALYZE** (or blank "menu" button) to advance to the **AUDIO RECORDING** screen.

AUDIO RECORDING  
ON

- Press the ▲ button to turn the option **ON** or **OFF**.

If the LIFEPAK 500 AED is not equipped with audio recording capability, this screen will not display.

23 Press **ANALYZE** (or blank "menu" button) to advance to the **INCIDENT ID** screen.

INCIDENT ID  
ON

- Press the ▲ button to change the setting (choices are **ON** and **OFF**).

24 Press **ANALYZE** (or blank "menu" button) to advance to the **AUDIO ALERT** screen. (This screen appears only on AEDs distributed in the English language.)

AUDIO ALERT

- Press the ▲ button to change the setting (choices are **ON** and **OFF**).

25 Press **ANALYZE** (or blank "menu" button) to advance to the **TRANSFER SETUP** screen.

TRANSFER SETUP  
TO SEND PUSH ►

- To transfer the setup to another AED, refer to the section that follows.
- To turn off the AED, press **ON/OFF**. The settings are saved.

---

## TRANSFERRING SETUP TO ANOTHER LIFEPAK 500 AED

You can transfer the clock setting and all setup information, except DEVICE ID, from one LIFEPAK 500 AED to an identical AED using the **TRANSFER SETUP** option. Identical AEDs are devices that have the same button configuration, software version, and defibrillation waveform.

**Note:** Only LIFEPAK 500 AEDs with software version 4.2 or later can transfer and receive setup data. Attempting to transfer setup data to devices with software version 4.0 may induce erroneous faults in the receiving device.

To transfer the setup:

- 1 From within the setup mode, press **ANALYZE** (or the blank "menu" button) to advance to the **TRANSFER SETUP** option. The AED displays the **TRANSFER SETUP** screen:



- 2 Connect the equipment as shown in Figure 2-4:
  - Connect the Setup Transfer Cable to the AED that has the setup you wish to transfer (original AED).
  - Connect the other end of the Setup Transfer Cable to the AED that you wish to receive the new setup (receiving AED).

**Note:** Both AEDs must have the same button configuration and defibrillation waveform.

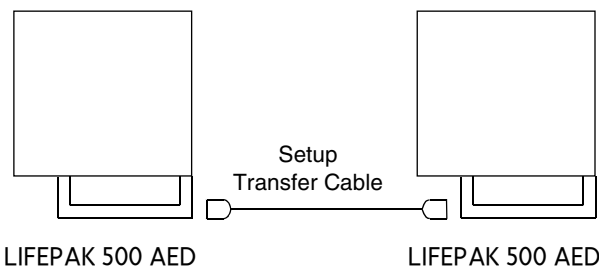

Figure 2-4 Setup transfer connections

- 3 Turn on the receiving AED and wait for **CONNECT ELECTRODES** message to appear.
- 4 Push the ► button on the original AED to send the setup to the receiving AED.
 

During setup transfer, the original AED displays the **SENDING** message. The receiving AED displays a blank screen.

After the original AED successfully transfers the setup, it displays the **SEND COMPLETE** message. The receiving AED turns itself off, turns itself back on, and then displays the **CONNECT ELECTRODES** message.
- 5 To transfer the setup from the original AED to additional AEDs:
  - Turn off the receiving AED.
  - Disconnect the Setup Transfer Cable from the receiving AED.
  - Repeat steps 2 through 4.
- 6 When finished, disconnect the Setup Transfer Cable, turn off both AEDs, and prepare them for patient use.

**Note:** The original AED does not transfer the device ID to the receiving AED. To change the device ID on a receiving AED, refer to the *LIFEPAK 500 Automated External Defibrillator Setup Instructions* (CAT. 26500-001011).

## CONNECTING ELECTRODES TO THE AED

You can connect the QUIK-COMBO electrodes with the REDI-PAK preconnect system to the AED before patient care to save time. To connect the REDI-PAK-type QUIK-COMBO electrodes:

- 1 Inspect the electrode package and confirm that the expiration date has not passed.
- 2 Remove the clear plastic pouch to expose the QUIK-COMBO electrode connector.



- 3 Open the connector cover on the AED as shown in Figure 2-5.
- 4 Insert the electrode connector firmly into the cable connector on the AED as shown in Figure 2-5.

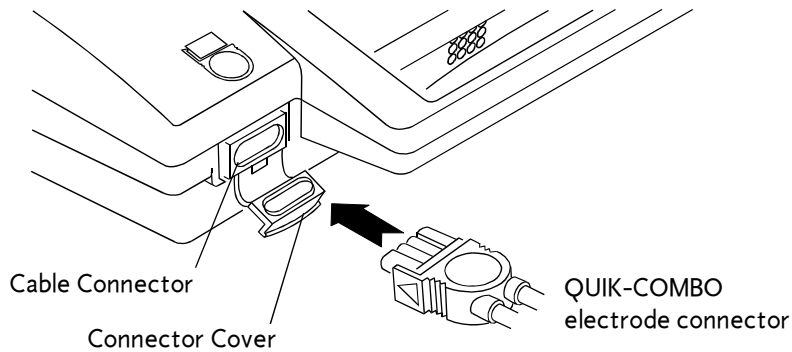

Figure 2-5 Connecting the QUIK-COMBO electrodes

- 5 Store the electrodes in the carrying case or the electrode storage tray.
- 6 Do not open the electrode package until immediately prior to patient use.

If you use QUIK-COMBO electrodes without the REDI-PAK preconnect system, you should:

- Not open the electrode package until immediately prior to patient use.
- Inspect the electrode package and confirm that the expiration date has not passed.
- Store the electrode package in the carrying case or electrode storage tray.
- When ready for patient use, open the electrode package and connect the electrodes to the AED as shown in Figure 2-5 above.

**Note:** If you are using FAST-PATCH electrodes, refer to Appendix C. If you want to use Infant/Child Reduced Energy Defibrillation Electrodes, purchase the Infant/Child Reduced Energy Defibrillation Electrodes Starter Kit (CAT. 41330-000005 or CAT. 41330-000006).

## USING THE LIFEPAK 500 AED

This section describes how to use the LIFEPAK 500 Automated External Defibrillator (AED) for ECG analysis and defibrillation. The actual clinical procedures that you use may vary according to your local protocol.

Warnings and Cautions	page 3-2
Preparing the AED for Operation	3-2
AED Operation	3-3
AED Prompts	3-5
Transferring Patient Care to another AED	3-9
Troubleshooting During Patient Care	3-10

## WARNINGS AND CAUTIONS

### WARNINGS!

#### Shock hazard.

This defibrillator delivers up to 360 joules of electrical energy. When discharging the defibrillator, do not touch the disposable therapy electrodes.

#### Shock hazard.

If a person is touching the patient, bed, or any conductive material in contact with the patient during defibrillation, the delivered energy may be partially discharged through that person. Clear everyone from contact with the patient, bed, and other conductive material before discharging the defibrillator.

#### Shock hazard.

To remove an unwanted charge, disconnect the electrode cable from the device, wait for the device to automatically remove the charge, or turn off the AED.

#### Possible fire, burns, and ineffective energy delivery.

Do not discharge standard paddles on top of therapy electrodes or ECG electrodes. Do not allow therapy electrodes to touch each other, ECG electrodes, lead wires, dressings, transdermal patches, etc. Such contact can cause electrical arcing and patient skin burns during defibrillation and may divert defibrillating energy away from the heart muscle.

#### Possible skin burns.

During defibrillation, air pockets between the skin and therapy electrodes can cause patient skin burns. Apply therapy electrodes so that entire electrode adheres to skin. Do not reposition the electrodes once applied. If the position must be changed, remove and replace with new electrodes.

#### Possible skin burns and ineffective energy delivery.

Therapy electrodes that are dried out or damaged may cause electrical arcing and patient skin burns during defibrillation. Do not use electrodes that have been removed from foil package for more than 24 hours. Do not use electrodes beyond expiration date. Check that electrode adhesive is intact and undamaged. Replace therapy electrodes after 50 shocks.

### CAUTION!

#### Possible equipment damage.

Before using this AED, disconnect all equipment from the patient that is not defibrillator-protected.

## PREPARING THE AED FOR OPERATION

Follow these steps to help ensure that the AED is always ready for use:

- Properly maintain the AED and batteries as described on page 5-7 of this manual.
- Make sure that the defibrillation electrodes are available and properly stored in the AED carrying case or electrode tray.
- Keep the following supplies readily accessible:
  - Spare, properly maintained battery
  - Spare defibrillation electrodes
  - Supplies to clean and shave the electrode sites on the patient
- Keep the AED and accessories within an optimal temperature range of 15–35° C (59–95° F).

QUIK-COMBO and FAST-PATCH electrodes are pre-gelled, self-adhesive electrodes that allow hands-free defibrillation. They are designed for use with devices equipped with the appropriate connector or therapy cable. For more information about these electrodes, refer to the respective electrode operating instructions.

## AED OPERATION

To prepare for ECG analysis and defibrillation:

- 1 Verify that the patient is in cardiac arrest (the patient is unconscious, not breathing normally and shows no signs of circulation, for example, no pulse, and/or no coughing, no movement).
- 2 Press **ON/OFF** to turn on the AED (the green LED will light). The **CONNECT ELECTRODES** message and voice prompt will occur until the patient is connected to the AED.
- 3 Prepare the patient for electrode placement:
  - If possible, place the patient on a hard surface away from standing water.
  - Remove clothing from the patient's upper torso.
  - Remove excessive hair from the electrode sites. If shaving is necessary, avoid cutting the skin.
  - Clean the skin and dry it briskly with a towel or gauze.
  - Do not apply alcohol, tincture of benzoin, or antiperspirant to the skin.
- 4 Apply the electrodes to the patient's chest:
  - Place the ♥ or + electrode lateral to the patient's left nipple with the center of the electrode in the midaxillary line, if possible. (See Figure 3-1.)
  - Place the other electrode on the patient's upper right torso, lateral to the sternum and below the clavicle as shown in Figure 3-1.
  - Starting from one end, press the electrodes firmly onto the patient's skin.

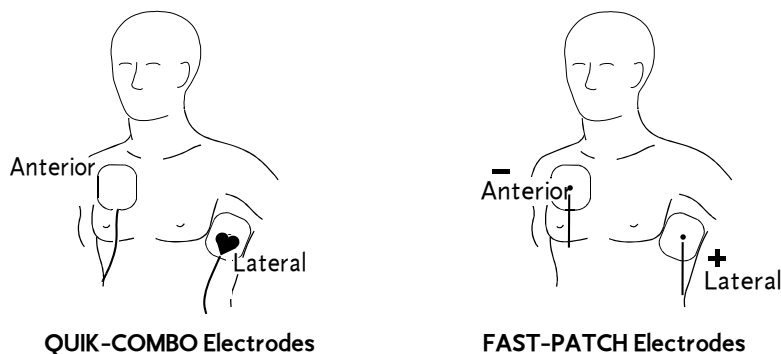

Figure 3-1 Anterior-lateral position

- 5 Connect the electrode connector to the AED (if it is not already connected).
- 6 Follow the screen messages and voice prompts provided by the AED.

If the patient recovers consciousness and/or signs of circulation and breathing return, place the patient in the recovery position and leave the AED attached.

## Special Situations for Electrode Placement

When placing electrodes on the patient, be aware of the following special situations.

### Obese Patients or Patients with Large Breasts

Apply the electrodes to a flat area on the chest, if possible. If skin folds or breast tissue prevent good adhesion, spread skin folds apart to create a flat surface.

### Thin Patients

Follow the contour of the ribs and spaces when pressing the electrodes onto the torso. This limits air space or gaps under the electrodes and promotes good skin contact.

#### WARNING!

Possible interference with implanted electrical device.

Defibrillation may cause implanted electrical devices to malfunction. Place therapy electrodes away from implanted devices if possible. Check implanted device function after defibrillation.

### Patients with Implanted Pacemakers

If possible, place defibrillation electrodes away from the internal pacemaker generator. Treat this patient like any other patient requiring emergency care. Pacemaker pulses may prevent advisement of an appropriate shock, regardless of the patient's underlying rhythm.

### Patients with Implanted Defibrillators

Apply the electrodes in the anterior-lateral position. Treat this patient like any other patient requiring emergency care.

### Alternate Anterior-Posterior Electrode Position

The electrodes may be placed in an anterior-posterior position as follows:

- 1 Place either the ♥ or + therapy electrode over the left precordium as shown in Figure 3-2. The upper edge of the electrode should be below the nipple. Avoid placement over the nipple, the diaphragm, or the bony prominence of the sternum if possible.
- 2 Place the other electrode behind the heart in the infrascapular area as shown in Figure 3-2. For patient comfort, place the cable connection away from the spine. Do not place the electrode over the bony prominences of the spine or scapula.

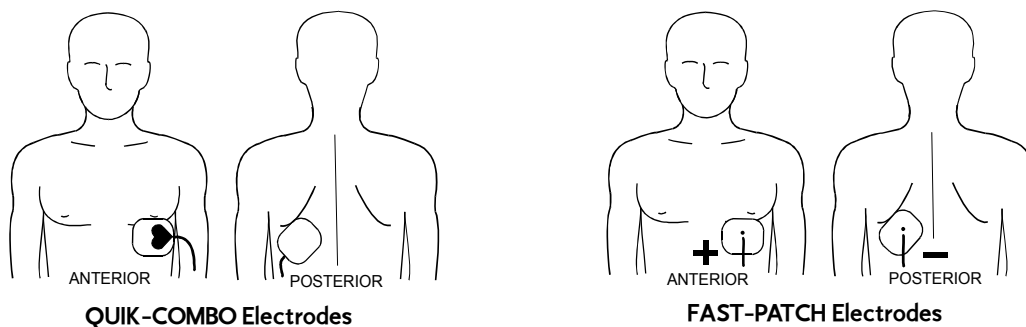

Figure 3-2 Anterior-posterior placement

## Using the LIFEPAK 500 AED

### AED PROMPTS

The following paragraphs describe AED operation when the AED setup options are set to the default settings. Topics include:

- First analysis cycle
- **SHOCK ADVISED** sequence
- **NO SHOCK ADVISED** sequence
- CPR timer
- Shock counter
- Motion detection
- Electrodes off detection
- Special setup options – **INITIAL CPR** and **PRE-SHOCK CPR TIME**

For a more detailed description of how the AED analyzes the patient ECG, refer to page A-3.

#### WARNING!

##### Possible misinterpretation of data.

Do not analyze in a moving vehicle. Motion artifact may affect the ECG signal resulting in an inappropriate shock or no shock advised message. Motion detection may delay analysis. Stop vehicle and stand clear of patient during analysis.

##### Possible misinterpretation of data.

Do not move the AED during analysis. Moving the AED during analysis may affect the ECG signal resulting in an inappropriate shock or no shock advised decision. Do not touch the patient or the AED during analysis.

### First Analysis Cycle

When you turn on the power and first apply electrodes to the patient, the AED will either analyze automatically or prompt you to press **ANALYZE**, depending on the auto analyze configuration.

If you hear the **PUSH ANALYZE** voice prompt and see the **ANALYZE** LED flash, press **ANALYZE**.

When the AED begins to analyze the patient's ECG, the AED beeps twice and the following two messages alternately appear.

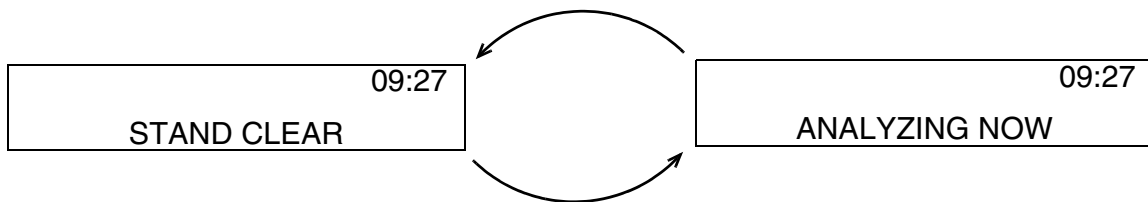

You will hear the **STAND CLEAR, ANALYZING NOW, STAND CLEAR** voice prompt. The ECG analysis requires about 9 to 13 seconds. The **ANALYZE** LED (if present) is on during analysis.

### Shock Advised

If the AED detects a shockable ECG rhythm, the following message appears.



You will hear the **SHOCK ADVISED** voice prompt. The AED begins charging for Shock #1. A rising tone indicates that the AED is charging.

When charging is complete, the following two messages alternately appear.

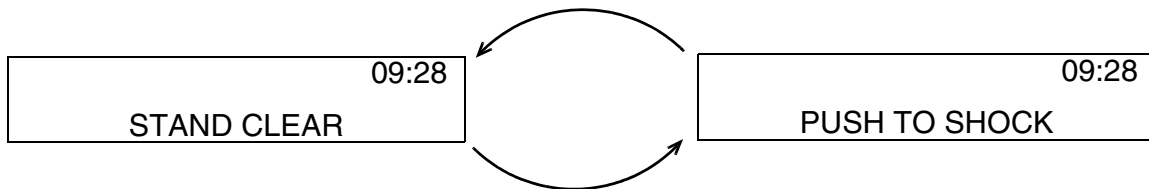

You will hear the **STAND CLEAR, PUSH TO SHOCK** voice prompt followed by the "shock ready" tone (a loud, high-pitched, two-tone sound). The **SHOCK** LED flashes.

- Check that no one is touching the patient.
- Press **SHOCK** to discharge the AED. After the shock, you will hear the **START CPR** prompt.
- If you do not press **SHOCK** within 30 seconds, the AED disarms the **SHOCK** button, and the **CHARGE REMOVED** message appears.

### No Shock Advised

If the AED detects a nonshockable ECG rhythm, the following message appears.



You will hear the **NO SHOCK ADVISED** prompt. The AED will not charge, and no shock can be delivered. You will then hear the **START CPR** prompt.

### CPR Timer

After a shock is delivered or after a **NO SHOCK ADVISED** decision, the AED prompts **START CPR**. The countdown CPR timer indicates the amount of CPR time remaining.

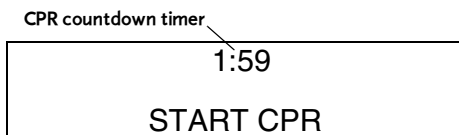

### After CPR Time

After the CPR time has elapsed, the AED prompts **PUSH ANALYZE** or analyzes automatically, depending on the auto analyze setting.

If you hear the **PUSH ANALYZE** voice prompt and see the **ANALYZE** LED flash, press **ANALYZE**. When the AED begins to analyze the patient's ECG, the AED beeps twice and the following two messages alternately appear.

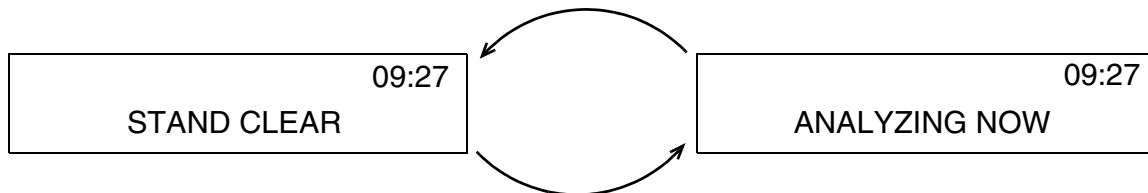

You will hear the **STAND CLEAR, ANALYZING NOW, STAND CLEAR** voice prompt. The ECG analysis requires about 9 to 13 seconds. The **ANALYZE** LED (if present) is on during analysis.

**Note:** If **AUTO ANALYZE 2** is selected (or for LIFEPAK 500 AEDs that do not have an **ANALYZE** button), analysis will begin automatically at the end of the CPR time. You will hear **STAND CLEAR, ANALYZING NOW, STAND CLEAR**. Stop CPR immediately and stay clear of the patient during the analysis.

### Shock Counter

The shock counter appears in the upper-left corner of the LCD.

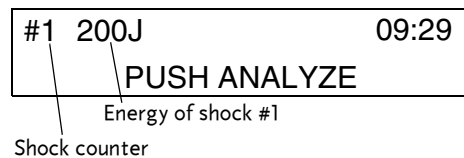

The shock counter indicates how many shocks have been delivered to the patient. Following the shock counter, the energy for that shock number may be displayed (optional). The shock counter resets whenever the AED is turned off for at least 60 seconds.

### Motion Detection

If the AED is configured with **MOTION DETECTION ON** and motion is detected during the ECG analysis, the following two messages alternately appear.

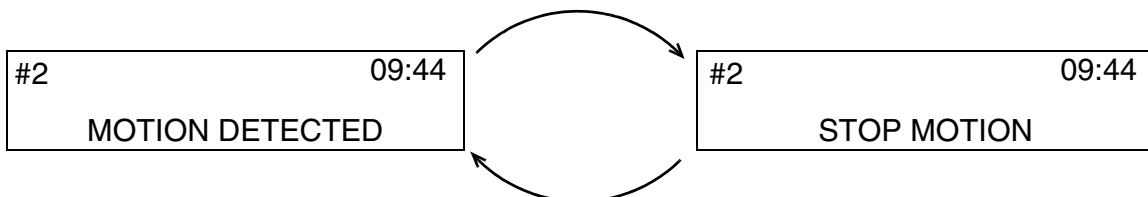

You will hear the **MOTION DETECTED, STOP MOTION** voice prompt, followed by a warning tone. When motion is detected, analysis is prevented for up to 10 seconds. After 10 seconds, analysis continues regardless of whether or not motion is present. Refer to troubleshooting on page 6-2 for possible causes and suggested actions.



If the AED is configured with **MOTION DETECTION OFF**, the ECG analysis proceeds uninhibited by the presence of motion. There is no **MOTION DETECTED** verbal or text prompt if motion is present during ECG analysis.

### Electrodes Off Detection

If the AED detects that the electrodes are not properly connected to the AED or the patient, the following message appears.



You will hear the **CONNECT ELECTRODES** voice prompt followed by three warning beeps. Refer to troubleshooting on page 6-2 for possible causes and suggested actions.

### Asystole Detector

If the AED has been configured for the asystole detector to be active, the following message appears after **NO SHOCK ADVISED** decisions occur with asystole present and when the asystole detector time interval has been reached.



You will hear the **ASYSTOLE** voice prompt, which will repeat periodically until the next analysis.

### Special Setup Options

#### Initial CPR – CPR FIRST

When the **INITIAL CPR** option is set to **CPR FIRST**, you will be prompted to **START CPR** immediately after the AED is turned on. A countdown timer shows the remaining time for the initial CPR period. You will then see and hear the **IF YOU WITNESSED THE ARREST, PUSH ►** prompt. This provides an opportunity to end initial CPR early and proceed to analysis. The decision to end CPR early is based on the protocol defined by your medical director.

- If the ► button is pressed, you will be prompted to **CONNECT ELECTRODES**. If electrodes are already connected, you will be prompted to proceed to analysis.
- If the ► button is NOT pressed, the countdown will continue to the end of the initial CPR time. At the end of CPR time, you will be prompted to **CONNECT ELECTRODES**. If electrodes are already connected, you will be prompted to proceed to analysis.

#### Initial CPR – ANALYZE FIRST

When the **INITIAL CPR** option is set to **ANALYZE FIRST**, you will be prompted to perform analysis after the AED is turned on. CPR is prompted after the AED completes the analysis. The AED prompting based on the analysis decision is described in the following paragraphs.

## Using the LIFEPAK 500 AED

**NO SHOCK ADVISED** — If the AED detects a nonshockable ECG rhythm, it prompts you to immediately start CPR and the following message appears.

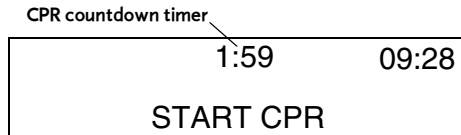

The CPR time continues for the duration specified in the setup option (for example, 120 seconds). After the CPR time elapses, an analysis cycle is prompted.

**SHOCK ADVISED** — If the AED detects a shockable ECG rhythm, the following two messages alternately appear.

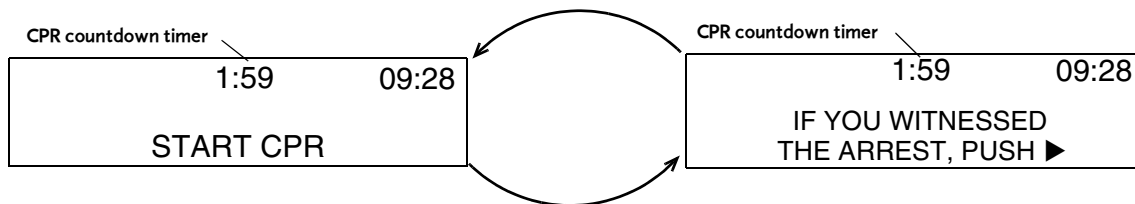

After a shockable rhythm is detected, you will hear **START CPR**, followed by **IF YOU WITNESSED THE ARREST, PUSH RIGHT ARROW**, which provides the opportunity to end CPR early. The decision to end CPR early is based on the protocol defined by your medical director.

- If you press the ► button to end CPR early, you will hear **SHOCK ADVISED**, followed by a charging tone. Proceed according to your training with the AED for delivering the shock.
- If you do not press the ► button, CPR continues for the length of time specified in the setup option (for example, 120 seconds). The AED charges during the CPR time in preparation for the shock. You will then hear **SHOCK ADVISED**. Proceed according to your training with the AED for delivering a shock.

### Pre-Shock CPR Time

When **PRE-SHOCK CPR TIME** is set to 15 seconds or more, you are prompted to start CPR immediately after a shockable rhythm is detected, before the shock is delivered. After the analysis is complete, the following message appears:

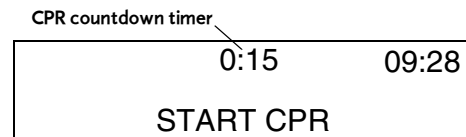

The CPR time continues for the duration specified in the **PRE-SHOCK CPR TIME** setup option (for example, 15 seconds). The AED charges during the CPR time in preparation for the shock. The **SHOCK** button is disabled during the pre-shock CPR interval to avoid accidental shock delivery while the defibrillator is charged and a responder performs CPR. After the CPR time elapses, you will hear the **SHOCK ADVISED** voice prompt. Proceed according to your training for delivering a shock with the AED.

## TRANSFERRING PATIENT CARE TO ANOTHER AED

To transfer patient care between devices equipped with identical therapy cable connectors:

- 1 Turn off the AED connected to the patient.
- 2 Leave the defibrillation electrodes on the patient; disconnect the electrodes from the therapy cable or the AED.
- 3 Connect the therapy electrodes to the next AED.

To transfer patient care between AEDs not equipped with identical therapy cable connectors:

- 1 Turn off the AED connected to the patient.
- 2 Remove the defibrillation electrodes currently on the patient.
- 3 Apply defibrillation electrodes that are compatible with the receiving AED.
- 4 Follow the instructions for the receiving AED.

---

## **TROUBLESHOOTING DURING PATIENT CARE**

For troubleshooting during patient care, refer to Table 6-1 on page 6-2.

## DATA MANAGEMENT

This section describes how to store and transfer LIFEPAK 500 Automated External Defibrillator (AED) data to a computer or a modem. Topics include:

Overview of Data Storage and Retrieval	page 4-2
Sending Data to a Computer by Modem	4-5
Sending Data to a Computer by Direct Connection	4-8

**OVERVIEW OF DATA STORAGE AND RETRIEVAL**

Every time you use the LIFEPAK 500 AED on a patient, data is stored digitally inside the AED. This data allows post-incident review for quality control, training, and research purposes. Print or transfer this data as soon as possible to save the information.

The following paragraphs describe how the LIFEPAK 500 AED stores and retrieves data.

**Overview of Data Storage**

Whenever power is on, the LIFEPAK 500 AED automatically stores the data illustrated in Figure 4-1.

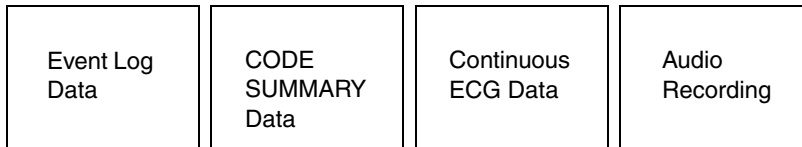

Figure 4-1 Data stored by the LIFEPAK 500 AED

- Event Log Data — A chronological log of all events. An event is a specific action by the operator or AED, such as:
  - Power on
  - Patient connected
  - Analysis started
  - Shock advised
  - Shock delivered

Refer to the following table for a list of all the event types.

Table 4-1 LIFEPAK 500 AED Event Types

Possible Event Types*
<b>Event Log Report</b>
POWER ON
PATIENT CONNECTED
ANALYSIS X
SHOCK X - XXXJ
CPR PROMPT
CHECK PATIENT
CHARGE REMOVED
BATTERY REMOVED
BATTERY REPLACED
MOTION DETECTED
ANALYSIS STOPPED
OUT OF EVENT MEMORY
OUT OF ECG MEMORY
OUT OF SCENE AUDIO MEMORY
POWER OFF

Table 4-1 LIFEPAK 500 AED Event Types (Continued)

Possible Event Types*
Event Log Summary
FIRST ANALYSIS
FIRST SHOCK
# SHOCK(S) DELIVERED

\* These events and all voice prompts may appear in the Event Log Report.

- CODE SUMMARY™ Data — A summary of critical resuscitation events and the ECG rhythm segments associated with those events.
- Continuous ECG Data — Between 20 and 80 minutes of the patient ECG rhythm from the time of power-on to power-off. Varies with the configuration of the AED and whether Audio Recording is installed and enabled. (Refer to Specifications, page 5-15.) Data collection stops when maximum recording times are exceeded.
- Audio Recording — Approximately 20 minutes of audio data recorded at the scene, such as operator remarks and AED voice prompts or tones. (The audio recording option must be installed and enabled.) Data collection stops when maximum recording times are exceeded.

**Patient Records**

A patient record is created when the AED is connected to a patient and begins to store data. The AED stores data from the time that you turn the AED on until you turn the AED off. The LIFEPAK 500 AED can store a maximum of two patient records:

- Current Patient — The most recent patient record stored
- Previous Patient — The patient record stored prior to the Current Patient

The data stored for the Current Patient and Previous Patient is illustrated in Figure 4-2.

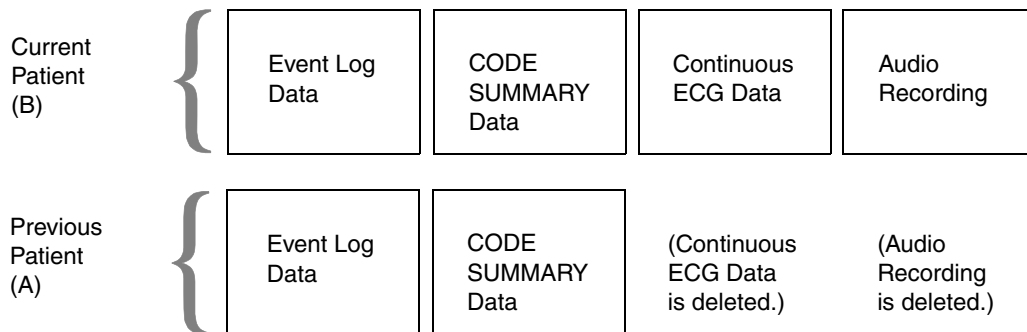

Figure 4-2 Comparison of data stored for the Current Patient and Previous Patient

The AED stores all data for the Current Patient (B). However, the AED only retains the Event Log and CODE SUMMARY data for the Previous Patient (A).

**Information Stored When Creating a New Patient Record**

When the AED creates a new patient record, the following occurs:

- The AED stores all data for the newest patient record, Patient C (refer to Figure 4-3). Patient C is now the Current Patient.
- The AED deletes the ECG and audio recording data for Patient B. The AED retains only the Event Log and CODE SUMMARY data. Patient B is now the Previous Patient.
- The AED deletes all data for the oldest patient record, Patient A.

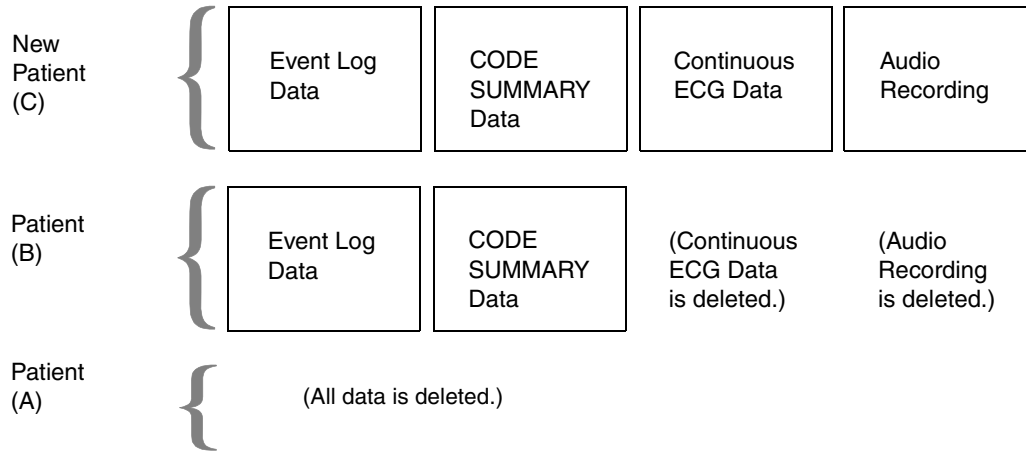

Figure 4-3 Data stored when the AED stores a new patient record

**Conditions for Creating a New Patient Record**

To begin a new patient record, the following conditions must occur:

- The AED must be turned off for at least 60 seconds, then turned on.
- Electrodes must be connected to the patient.

You can turn off the AED briefly without affecting the Current Patient. For example, you can change the battery. If you restore power in less than 60 seconds, the AED resumes storing data for the Current Patient.

If you do not connect electrodes to a patient or a simulator, you can turn on the AED and not affect the Current Patient. For example, you can turn on the AED to test it with the external test load or to transfer data. As long as you do not connect the electrodes to a new patient or an ECG simulator, the AED does not create a new patient record.

As soon as you turn on the AED, the AED begins storing data for a new patient record. However, if you do not connect electrodes to a patient within 3 minutes, the AED stops storing data.

- If you then connect electrodes, the AED resumes storing data and creates a new Current Patient.
- If, however, you turn off the AED without ever connecting the electrodes, the AED does *not* create a new Current Patient. The AED will delete the initial 3 minutes of data, and all previously stored data will remain unchanged. This prevents erasing data each time you turn on the AED to transfer data or perform maintenance.

### Test Log

The LIFEPAK 500 AED also stores a Test Log, a list of the 30 most recent auto-tests and manual tests. The Test Log lists the test results and any fault codes detected. The Test Log is printed automatically when data is sent to a printer. As an option, the Test Log may be printed from a computer.

### Overview of Data Retrieval

There are two ways you can retrieve data from the LIFEPAK 500 AED:

- Send the data to a computer by modem.
- Send the data to a computer by direct connection.

The AED does not delete data after it is transferred. Data is only deleted when new patient records are created. Table 4-2 describes the stored data and how you can retrieve it.

Table 4-2 LIFEPAK 500 AED Data and Retrieval

Type of Data	Retrieval	
	Modem	Computer
Event Log Data	Yes	Yes
CODE SUMMARY data	Yes	Yes
Continuous ECG*	Yes	Yes
Audio Recording <sup>†</sup>	Yes <sup>2</sup>	Yes <sup>2</sup>
Test Log	Yes	Yes

\* Available for the Current Patient only.

<sup>†</sup> To play the audio recordings, a sound card, sound card software, and the QUIK-VIEW 500 data review program or CODE-STAT data management system must be installed in the computer.

### SENDING DATA TO A COMPUTER BY MODEM

These paragraphs describe the resources, equipment connections, and procedures required to send LIFEPAK 500 AED data to a computer by modem.

#### Required Resources

Table 4-3 summarizes the resources required to send data to a computer by modem.

Table 4-3 Required Resources for Sending Data to a Computer by Modem

Description
<b>Required Resources at Local Site</b>
Modem cable (for use with LIFEPAK 500 AED)
Modem that supports the TIA/EIA-602 command set



Table 4-3 Required Resources for Sending Data to a Computer by Modem (Continued)

Description	
Modem power cord or power adapter (if required)	
Telephone cord (with RJ11 connectors)	
Analog telephone line*	
Required Resources at Destination Site	
Modem that supports the Hayes AT command set	
Personal Computer:	<ul style="list-style-type: none"> <li>– QUIK-VIEW 500 data review program or CODE-STAT data management system</li> <li>– Microsoft Windows 3.1 or later for Data Transfer 500, and for QUIK-VIEW 500 if audio review is not needed. Microsoft Windows 95 for QUIK-VIEW 500 if audio review is needed</li> <li>– Microsoft Windows 95 or Windows NT 4.0 for CODE-STAT 3.2 or earlier and Windows 98, Windows ME, Windows 2000 Professional, or Windows NT version 4.0 with Service Pack 1 for CODE-STAT 4.0 or later.</li> </ul>
Cables as required	
Analog telephone line*	

\* Most internal telephone lines for integrated office telephone systems are digital lines. Make sure you connect the modem to an external analog telephone line like the type used for fax machines.

## Setup Options

Make sure the AED setup options are properly defined for the modem initialization string and destination phone number. Refer to page 2-7 for information about the modem setup options.

**Note:** Remember to include in the dial string any special characters that are required to dial the destination (such as "9" or a pause).

## Procedure for Sending Data

Perform these steps to send data:

- 1 Make sure the equipment at the destination site is properly connected.
- 2 Make sure the destination computer power is on and that the QUIK-VIEW 500 data review program or CODE-STAT data management system is ready to receive data.
- 3 Make sure the modem is off and that the AED is turned off for at least 60 seconds.
- 4 At the local site, connect the equipment as shown in Figure 4-4.
  - Connect the modem cable to the AED and the modem.
  - Connect the telephone cord to the modem and the analog telephone line.
  - Connect the modem power cord or power adapter to a power source (if required).

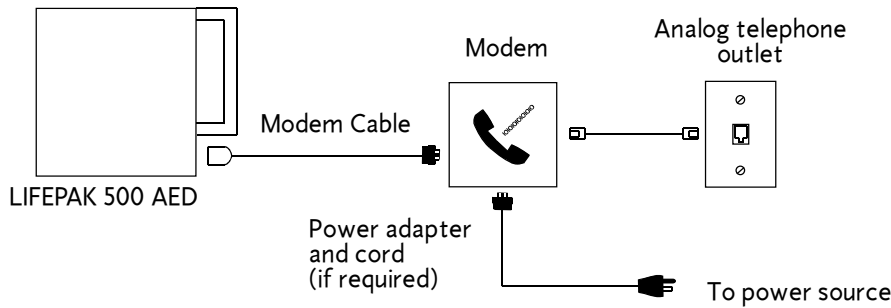

Figure 4-4 Equipment connections for data transfer by modem

- 5 Turn on the modem.
- 6 Press **ON/OFF** to turn on the AED. You will see:  
**BATTERY** status message  
**SELF-TEST** xx.xx message
- 7 After a few seconds, you will see the following message:  
**TO SEND PUSH** ►  
**Note:** If **INITIAL CPR** is set to **CPR FIRST**, press ► to exit **INITIAL CPR**.
  - Press ► to send the Current Patient.
  - Press ▲ to send the Previous Patient.
  - Press both ► and ▲ to send the Current and Previous Patients.
- 8 If the Incident ID option is **ON** and an Incident ID has *not* already been entered for the Current or Previous Patient, you will see the following message:  
**ENTER CURRENT [or PREVIOUS] ID?**  
**YES**
  - Press **ANALYZE** (or the blank "menu" button) to answer **YES**; or
  - Press ▲ to change to **NO**. Then press **ANALYZE** (or the blank "menu" button) and continue with step 10.
- 9 If you answered **YES**, you will see the following message:  
**INCIDENT ID**  
XXXXXXXXXX
  - Press ▲ to scroll through and select from the alphanumeric characters available.
  - Press ► to advance to the next field.
  - Repeat this process until the Incident ID is entered.
  - Press **ANALYZE** (or the blank "menu" button) to accept the Incident ID.**Note:** The last Incident ID entered will always be displayed.
- 10 Verify Incident ID entered. You will see the message:  
XXXXXXXXXX  
**OK TO SEND? YES**
  - Press **ANALYZE** (or blank "menu" button) to accept and send the Incident ID.
  - Press ▲ to change to **NO**.
  - Press **ANALYZE** (or blank "menu" button) to return to Incident ID screen.
  - Follow step 9 beginning with bulleted items to change the Incident ID.

- 11 After **ANALYZE** (or the blank "menu" button) is pressed, the AED transfers the patient data. While the data is being transferred, the AED displays the following message to indicate progress:

**SENDING  
XX%COMPLETE**

After the AED successfully completes the data transfer, it displays the **SEND COMPLETE** message.

- 12 After the AED displays the **SEND COMPLETE** message, check that the low battery indicator is not displayed.
- 13 Turn off the AED and prepare it for the next patient use.

**Note:** If you leave the LIFEPAK 500 AED unattended during data transfer, the AED automatically turns off after 15 minutes of no activity (after data transfer completed).

If the AED turns off, check the data transfer status:

- 1 Leave the data cable connected to AED and modem.
- 2 Turn on AED and look for the **SEND COMPLETE** message. If the **CANNOT SEND** message appears, refer to Table 6-2 on page 6-4 for troubleshooting tips.
- 3 If the **SEND COMPLETE** message appears:
  - Check that the low battery indicator is not displayed.
  - Disconnect the data transfer cable.
- 4 Turn off the AED and prepare it for the next patient use.

---

## SENDING DATA TO A COMPUTER BY DIRECT CONNECTION

These paragraphs describe the resources, equipment connections, and procedures required to send AED data to a computer by direct connection.

### Required Resources

Table 4-4 summarizes the resources required to send data to a computer by direct connection.

Table 4-4 Required Resources for Sending Data to a Computer by Direct Connection

Description
PC Cable (for use with the LIFEPAK 500 AED)
Personal Computer: <ul style="list-style-type: none"> <li>– QUIK-VIEW 500 data review program or CODE-STAT data management system.</li> <li>– Microsoft Windows 3.1 or later for Data Transfer 500, and for QUIK-VIEW 500 if audio review is not needed. Microsoft Windows 95 for QUIK-VIEW 500 if audio review is needed.</li> <li>– Microsoft Windows 95 or Windows NT 4.0 for CODE-STAT 3.2 or earlier and Windows 98, Windows ME, Windows 2000 Professional, or Windows NT version 4.0 with Service Pack 1 for CODE-STAT 4.0 or later.</li> </ul>

## Procedure for Sending Data

Perform these steps to send data:

- 1 Make sure that the AED is turned off for at least 60 seconds.
- 2 Connect the equipment as shown in Figure 4-5.
- 3 Make sure that the computer power is on and that the application program is open.
- 4 Press **ON/OFF** to turn on the AED. The **CONNECT ELECTRODES** message appears and remains until data transfer begins.

**Note:** If **INITIAL CPR** is set to **CPR FIRST**, press ► to exit **INITIAL CPR**.

The computer controls the data transfer. Refer to the application program operating instructions for information about data transfer commands. The AED will not display any status messages during the data transfer.

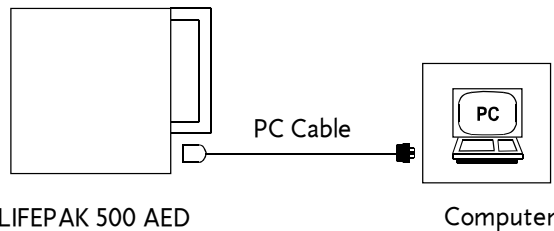

Figure 4-5 Equipment connections for data transfer by direct connection to a computer

- 5 When the computer is finished receiving data, do the following:
  - Check that the **LOW BATTERY** indicator is not displayed.
  - Disconnect the PC cable.
- 6 Turn off the AED and prepare it for the next patient use.

**Note:** If you leave the LIFEPAK 500 AED unattended during data transfer, the AED automatically turns off after 15 minutes of no activity (after data transfer completed).

If the AED turns off, check the data transfer status:

- 1 Check that the computer application program dialog box indicates that the patient record has been received. If the patient record has not been received, reinitiate procedure for sending data.
- 2 Turn on AED and check that the low battery indicator is not displayed.
- 3 Turn off the AED and prepare it for the next patient use.

## Troubleshooting During Data Transfer

If you cannot transfer data, refer to the application program operating instructions for troubleshooting information.



## MAINTENANCE

This section describes how to perform operator-level maintenance and testing on the LIFEPAK 500 Automated External Defibrillator (AED). For troubleshooting information, refer to page 6-2. Topics in this section include:

Maintenance and Testing Scheduling	page 5-2
Inspection	5-2
Cleaning	5-4
Testing	5-4
Battery Maintenance	5-7
Electrode Storage	5-13
Service and Repair	5-13
Warranty	5-14
Supplies, Accessories, and Training Tools	5-14
Specifications	5-15
Clinical Summary: Defibrillation of Ventricular Fibrillation and Ventricular Tachycardia	5-20

---

## MAINTENANCE AND TESTING SCHEDULING

The LIFEPAK 500 AED performs an automatic self-test every 24 hours. If the automatic self-test detects a low battery condition or a condition that requires service, AEDs with a readiness display will change the indicators on the display and will not activate an alarm unless **AUDIO ALERT** is configured **ON**. It is important to place the AED where the alarm is likely to be heard, to periodically inspect the AED, and to check display indicators (refer to the following inspection subsection).

The AED also performs a self-test every time you turn on the AED. These self-tests do not eliminate the need for regular maintenance. You should do the following on a regular basis and after each time the AED is used:

- Inspect the AED as described in Table 5-1.
- Clean the AED as described in Table 5-2.
- Check to make sure that all necessary supplies and accessories (such as properly-maintained batteries and therapy electrodes) are readily accessible.

Your local operator maintenance schedule should consider how familiar the operators are with AED operation, how often the AED is used, and the age of the AED batteries. If AED batteries are two years old or older, weekly inspection is recommended. If AED batteries are less than two years old, consider the following:

- If the AED is used on a weekly basis, daily inspections may be appropriate.
- If the AED is used on a monthly basis, weekly inspections may be appropriate.
- If the AED is used very infrequently, such as once a year, monthly inspections may be appropriate.

---

## INSPECTION

Routinely inspect all devices, accessories, and cables by following the instructions in Table 5-1.

Table 5-1 LIFEPAK 500 AED Inspection

Instruction	Inspect for	Recommended Corrective Action
Examine the AED case, connector, battery well, battery pins, and accessories.	Foreign substances.	Clean the device as described in Table 5-2.
	Damage or cracks.	Contact authorized service personnel to troubleshoot and repair parts.
	Battery pins bent or discolored.	Contact authorized service personnel to replace or repair parts.
	Expired batteries or defibrillation electrodes.	Replace.

---

Table 5-1 LIFEPAK 500 AED Inspection (Continued)

Instruction	Inspect for	Recommended Corrective Action
AEDs with readiness display: Observe readiness display	OK	None needed.
	Battery indicator displayed	Replace battery immediately.
	Service indicator displayed	Contact authorized service personnel to replace or repair parts.
AEDs without a readiness display: With the battery installed, press <b>ON/OFF</b> to turn on the AED.	<b>BATTERY OK SELF-TEST xx.xx</b> message.	None needed.
	Illumination and display of each LED, all indicators, and all LCD segments.	Contact authorized service personnel to repair or replace parts.
	<b>BATTERY LOW</b> or <b>REPLACE BATTERY SELF-TEST xx.xx</b> message.	Replace the battery immediately.
	Service indicator or <b>CALL SERVICE</b> message. 	Contact authorized service personnel to troubleshoot and repair the device.
Examine accessory cables.	Foreign substances.	Clean the cables as described in Table 5-2.
	Bend and flex the cable and inspect for cracks, damage, extreme wear, broken or bent connectors and pins.	Replace damaged or broken parts.
	Confirm that connectors engage securely.	Replace damaged or broken parts.



**CLEANING**

Clean the LIFEPAK 500 AED and accessories as described in Table 5-2. Use only the cleaning agents listed in the table.

**CAUTION!**

**Possible equipment damage.**

Do not clean any part of the AED or accessories with bleach, bleach dilution, or phenolic compounds. Do not use abrasive or flammable cleaning agents. Do not steam, autoclave, or gas-sterilize the LIFEPAK 500 AED or accessories.

Table 5-2 Recommended Cleaning Methods

Items	Cleaning Practice	Recommended Cleaning Agent
LIFEPAK 500 AED case, display, crevices, and accessories	Clean with damp sponge or cloth.	<ul style="list-style-type: none"> <li>• Quaternary ammonium compounds</li> <li>• Rubbing (isopropyl) alcohol</li> <li>• Peroxide (peracetic acid) solutions</li> </ul>

**TESTING**

This section describes the AED automatic self-tests and the test load test. If testing indicates a problem, refer to Troubleshooting on page 6-2. If you cannot correct the problem, remove the AED from active service and contact authorized service personnel.

The AED stores the results of auto tests and the external test load test in a test log. For information about retrieving test log data, refer to page 4-5.

**Service Indicator and Message**

The service indicator appears if the automatic self-test detects a problem that requires service.



————— Service indicator appears on the readiness display and on the key panel

If the service indicator appears on the key panel (but not flashing), you can still use the AED if it is needed for patient therapy. However, you should contact authorized service personnel to correct the problem as soon as possible. The service indicator will display until the problem is corrected.

If the automatic self-test detects a problem that requires immediate service (such as a malfunctioning charging circuit), the service indicator appears on the readiness display, the service indicator on the key panel flashes, and the **CALL SERVICE** message appears.



Readiness Display on Device Handle

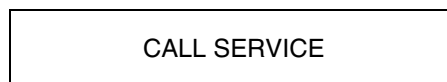

Display on Key Panel

Turn the AED off and on. If the **CALL SERVICE** message disappears, you can still use the AED if it is needed for patient therapy. However, you should contact authorized service personnel to correct the problem as soon as possible. If the **CALL SERVICE** message reappears, the service indicator on the device key panel will continue to flash and the message will remain on. Contact authorized service personnel immediately to correct the problem. You should not use the AED until the problem is corrected.

### Power-On Self-Test

Whenever the AED is turned off for at least 60 seconds and then turned on, the AED performs a “cold start.” During a cold start, the AED performs internal self-tests to check that internal electrical components and circuits work properly. During the self-test, the AED displays the following messages:

MEDTRONIC  
XXXX-XXXX

The xs indicate the software version installed.

BATTERY OK  
SELF-TEST xx.xx

If the AED requires service, the service indicator appears. Contact authorized service personnel to perform service.

**Note:** If the battery has an adequate charge to deliver therapy, you will see **OK** on the readiness display and the **BATTERY OK** message on the LCD during the self-test. If the battery is low, you will see a battery indicator on the readiness display, an illuminated battery indicator on the device key panel, and the **LOW BATTERY** message on the LCD. When the **LOW BATTERY** message first appears, the device will provide eleven or more shocks for a nonrechargeable battery and six or more shocks for a rechargeable battery. If the battery is very low, the **REPLACE BATTERY** message displays and the battery indicator on the key panel flashes. When the **REPLACE BATTERY** message first appears, the device will provide three or more shocks.

### Auto Tests

The AED periodically performs auto tests. During an auto test, the AED displays the following message:

BATTERY OK  
SELF-TEST xx.xx

If the AED detects a problem during an auto test that requires service but does not prevent AED use, it displays the service indicator the next time you turn on the AED.

**Note:** It is important that when the AED is stored with the battery installed, temperature exposure should not fall below 0°C (32°F) or exceed 50°C (122°F). If the AED is stored outside this temperature range, the auto tests may erroneously detect a problem and the AED may not operate properly.

### Daily Auto Test

Every day at 0300 (3:00 am) the AED automatically performs the following tasks:

- Turns itself on (the **ON/OFF** LED illuminates briefly).
- Performs self-test (**SELF-TEST** message displays).
- Stores the results in the Test Log.
- Turns itself off.

On a regular basis, the Daily Auto Test will test for low or replace battery conditions.

The Daily Auto Test is not performed if the AED is already turned on at 0300 or if the battery is not installed. If the AED is turned on while the Daily Auto Test is in progress, the test is halted; the AED will turn on normally.

### Extended Auto Test

The AED automatically turns on and performs the Extended Auto Test on a regular basis at 0300. In the Extended Auto Test, the AED performs the following tasks:

- Turns itself on (the **ON/OFF** LED illuminates briefly).
- Performs Extended Self-test (**SELF-TEST** message displays).
- Stores the results in the Test Log.
- Turns itself off.

To use the AED when the Extended Auto Test is in progress, push **ON** or connect the electrodes to the patient. The test will be halted and the AED will operate normally. The Extended Auto Test is not performed if the AED is already turned on at 0300 or if the battery is not installed.

### External Test Load Test

The external test load test checks the AED charging circuits and the operator's response during a typical ECG analysis and charging cycle. During this test, the AED charges for a low energy test shock. The usual messages and audio prompts are provided.

To perform the test load test:

- 1 Make sure that the AED is turned off.
- 2 Connect the test load to the cable connector receptacle on the AED.

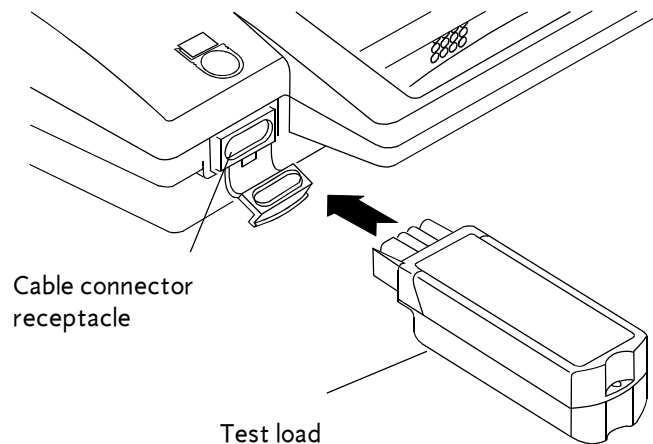

Figure 5-1 Test load connection

- 3 Press **ON/OFF** and observe that the **TEST MODE** message appears. (The **TEST MODE** message is displayed throughout the test.) If the **TEST MODE** message does not display, reconnect the test load and try again. If **AUTO ANALYZE** is off or **AUTO ANALYZE 1** is selected, you will see and hear:

**PUSH ANALYZE** message

**PUSH ANALYZE** voice prompt

- 4 Press **ANALYZE**. If **AUTO ANALYZE 2** is selected or you have an AED that does not have an **ANALYZE** button, the AED will start analyzing automatically.

You will see and hear:

**ANALYZING NOW** and **STAND CLEAR** messages

**ANALYZING NOW, STAND CLEAR** voice prompts

After a few seconds you will see and hear:

**SHOCK ADVISED** message

**SHOCK ADVISED** voice prompt

A rising charging tone that simulates a typical charge time

- 5 When the AED is fully charged, you will see and hear:

**STAND CLEAR** and **PUSH TO SHOCK** messages

**STAND CLEAR** and **PUSH TO SHOCK** voice prompts

- 6 Press **SHOCK** to discharge the energy into the test load.

- 7 Confirm that the AED displays the **TEST OK** message.

- 8 Disconnect the test load.

- 9 Press **ON/OFF** to turn off the AED.

- 10 Prepare the AED for the next patient use.

After the test is complete, the AED records the results in the Test Log. If the AED detects a problem during the test, the service indicator and **CALL SERVICE** message appear. Contact authorized service personnel to perform service. To repeat the test, turn off the AED and then turn it on again.

## BATTERY MAINTENANCE

The LIFEPAK 500 AED can be powered by two types of batteries:

- LIFEPAK 500 nonrechargeable lithium sulfur dioxide (LiSO<sub>2</sub>) or lithium manganese dioxide (LiMnO<sub>2</sub>) battery pak
- LIFEPAK 500 rechargeable sealed lead-acid (SLA) battery pak

**Note:** Unless stated otherwise, references to nonrechargeable lithium batteries apply to both LiSO<sub>2</sub> and LiMnO<sub>2</sub> battery technologies.

Either type of battery may be installed. Follow the guidelines described in this section to help maximize battery life and performance. Use only Medtronic Battery Pak batteries with the LIFEPAK 500 AED.

### WARNINGS!

#### Inability to provide therapy.

The LIFEPAK 500 nonrechargeable lithium manganese dioxide battery pak does not fit in all LIFEPAK 500 AEDs. Use only with AEDs marked -003 inside the battery well.

#### Possible AED shutdown.

When the LIFEPAK 500 AED prompts **REPLACE BATTERY**, replace the battery immediately.

#### Possible loss of power during patient care.

Using an improperly maintained battery to power the AED may cause power failure without warning. Maintain batteries as described in these Operating Instructions.

**Note:** When a battery pak is removed from the AED, battery and service indicators appear on the readiness display. After replacing the battery pak, turn on the device to reset the readiness display.

### **Nonrechargeable Battery Pak**

The nonrechargeable lithium battery pak requires less maintenance than the rechargeable SLA battery pak since it never requires recharging. With the lithium battery pak installed, the LIFEPAK 500 AED automatically tests it as part of the Daily Auto Test. The AED also performs the battery test during each charge/discharge cycle and the first time the AED is turned on after a new battery has been installed.

To check the battery level, turn on the AED for at least 10 seconds and look for the **BATTERY** status message during the self-test. If there is no message, turn off the AED for at least one minute and then turn it on again. The battery status message should appear following the self-test. Do not check the status of more than two lithium batteries within a 15-minute period. The AED may not accommodate more frequent battery checks.

When optimally maintained, a new LiSO<sub>2</sub> battery pak has a capacity of 7.5 Amp hours, which is equivalent to 14 hours of "on time" or 312 discharges. A new LiMnO<sub>2</sub> battery pak has a capacity of 10.0 Amp hours, which is equivalent to 18 hours of "on time" or 416 discharges. Just turning the AED on ("on time") uses up battery capacity.

Each year, battery capacity decreases while the battery is in the AED because of the battery's normal self-discharge rate and the energy used by the AED auto tests. After four years with no patient use of the AED, approximately 35% of the useful life of the LiSO<sub>2</sub> battery remains and approximately 50% of the useful life of the LiMnO<sub>2</sub> battery remains (LiSO<sub>2</sub>: 4.9 hours of "on time" or 109 discharges and LiMnO<sub>2</sub>: 8.9 hours of "on time" or 208 discharges). Any patient use of the AED, "on time" and shocks, will reduce the battery's useful life further.

The life expectancy of an LiSO<sub>2</sub> battery pak can be described in terms of the battery pak's shelf life and active life. Shelf life is the length of time the battery pak can be stored separately from the AED before its capacity is depleted. An unused LiSO<sub>2</sub> battery pak has a five-year advertised shelf life. If an LiSO<sub>2</sub> battery pak is stored in an environment with temperatures ranging between 15°–35° C (59°–95° F), it will have some, but limited, battery capacity remaining at the end of five years. However, after the five year date, we recommend that the battery be discarded and not used.

Active life is the battery capacity when the battery pak is installed in an AED. The active life of an LiSO<sub>2</sub> will **not** be the same as its shelf life. Active life can range from 12 months to four years. The length of time is determined by several factors, such as:

- AED Usage (patient use and operator-initiated testing)
- AED Storage Environment (temperature)
- AED Automatic Self-tests

Figures 5-2 through 5-4 illustrate the effect of these factors with three different usage levels.

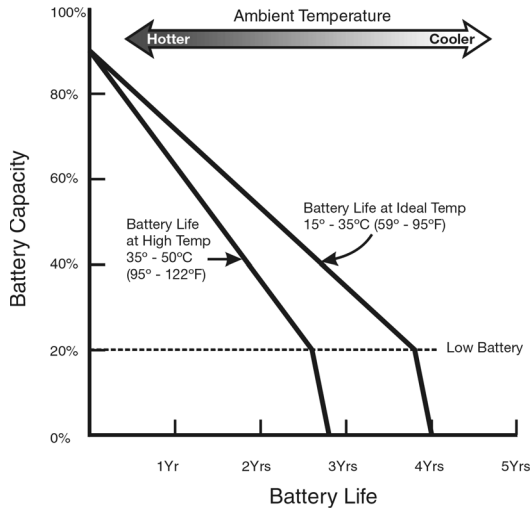

Figure 5-2 Active life, no patient use

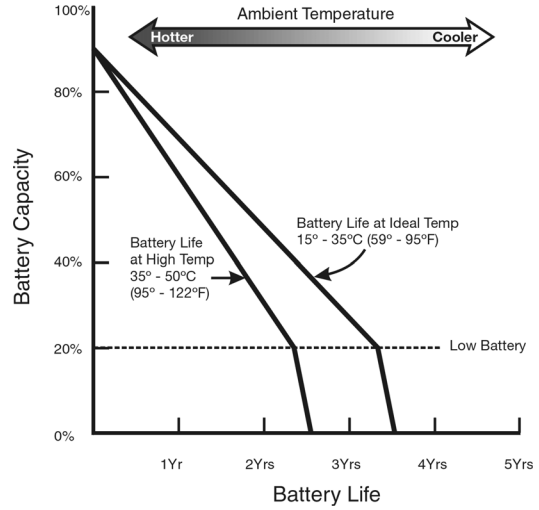

Figure 5-3 Active life, one patient use per year

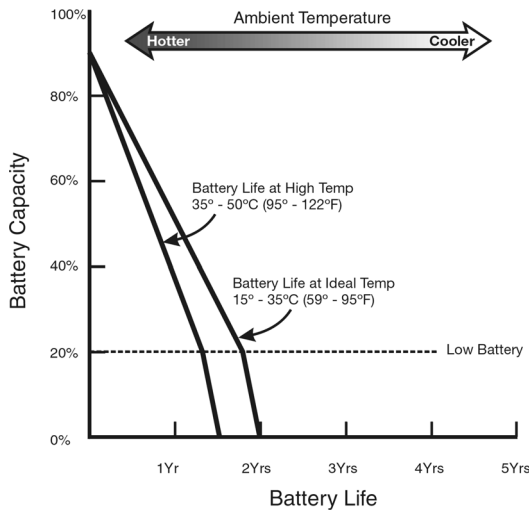

Figure 5-4 Active life, patient use every two months

The time for any particular battery to transition from a low battery to a battery depleted state varies greatly and is unpredictable due to differences in battery usage conditions. The transition time from low battery to battery depleted may be as short as 2 days. As a result, we recommend that you increase the frequency of your AED inspections, the longer a battery has been in an AED, in particular after two years. It is recommended to replace LiSO<sub>2</sub> batteries that have been installed in an AED for two years or more, regardless of usage.

To properly maintain nonrechargeable lithium battery paks:

- Do not attempt to recharge (lithium battery paks cannot be connected to the battery charger used to recharge the rechargeable SLA battery paks).
- Do not use beyond the expiration date marked on the battery label.
- Do not expose to temperatures greater than 50° C (122° F).
- Do not allow electrical connection between the battery contacts.
- Store individual battery paks and AEDs with batteries installed in an environment with temperatures between 15° and 35° C (59° and 95° F). Higher temperatures accelerate the loss of charge.

### WARNING!

#### Possible explosion, fire, or noxious gas.

Attempting to recharge a LIFEPAK 500 nonrechargeable lithium battery pak can cause an explosion or fire or release noxious gas. Dispose of expired or depleted lithium battery paks as described in these operating instructions.

### CAUTION!

#### Possible battery damage.

Electrical connection between battery contacts can blow an internal fuse and permanently disable the battery.

### Discharging Nonrechargeable Batteries

Before disposing of lithium battery paks, make sure that they are fully discharged. To discharge a lithium battery pak, follow this procedure:

- 1 Place the battery pak with the label side up on a firm, flat surface such as a table top or floor.
- 2 Locate the small slot on the corner marked by the arrow:

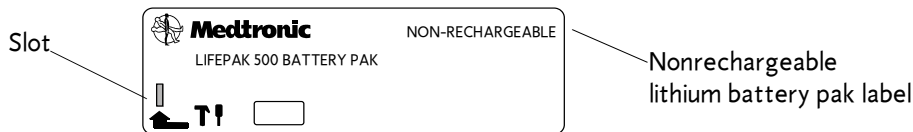

- 3 Place the tip of a flat-tipped screwdriver on the slot.
- 4 Using a hammer, strike a moderate blow straight down on the top of the screwdriver handle. Make sure that the tip of the screwdriver breaks the label and penetrates approximately 3 mm (1/8 inch). This will strike an internal pin, initiate full discharge, and permanently disable the battery.
- 5 Set the battery pak aside. Wait for at least 1 week to make sure that the battery pak is fully discharged before disposing.

### Disposing of Nonrechargeable Batteries

After fully discharging a lithium battery pak as described previously, dispose of the battery pak. Follow your national, regional, and local regulations for disposal. Contact a local Medtronic representative for more information.

In the USA, Environmental Protection Agency and Department of Transportation regulations allow disposal of lithium batteries with ordinary household waste **provided that they are fully discharged**. Be sure to comply with any other local or regional regulations before disposal. For more information or assistance, contact your local Medtronic representative or call 1.800.442.1142.

## Rechargeable Battery Pak

The rechargeable SLA battery pak requires more maintenance than a lithium battery pak since it must be recharged periodically. The SLA battery pak should be recharged monthly or after each use. SLA battery paks are most appropriate when the LIFEPAK 500 AED is used on a frequent basis and for those who use the AED with a simulator for training. With an SLA battery pak installed, the LIFEPAK 500 AED automatically turns on to test it as part of the Extended Auto Test. To check the battery level, turn on the AED and look for the **BATTERY OK** message during the self-test. Do not check the status of more than 3 SLA batteries within a 15-minute period.

When optimally maintained, a new SLA battery pak can provide approximately 3 hours of "on time" or 59 discharges during 3 months of use without recharging the battery. Just turning the AED on ("on time") uses up battery capacity. Each month, battery capacity decreases while the battery is in the AED because of the battery's normal self-discharge rate and the energy used by the AED self-tests. Figure 5-5 shows the expected capacity of the SLA battery pak without recharging over 3 months as a result of AED self-tests and battery self-discharge only. For example, after one month with no patient use of the AED, approximately 20% of the useful life of the battery has been depleted. Any patient use of the AED ("on time" and shocks) will reduce the capacity further. Even when properly maintained, SLA battery paks should be replaced every two years or after 200 charge cycles, whichever comes first.

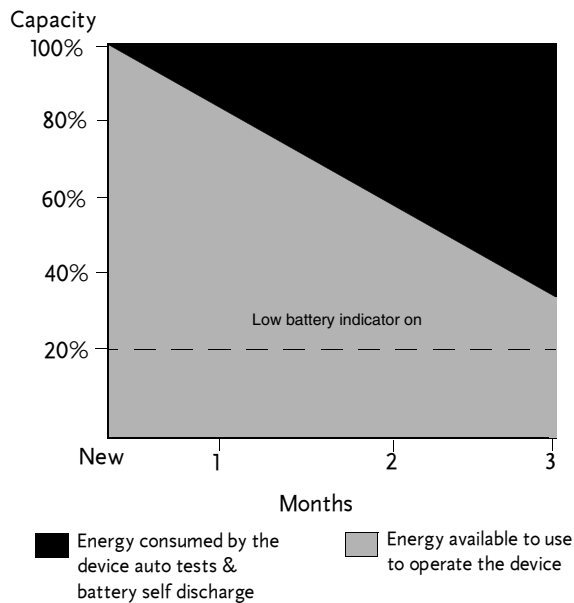

Figure 5-5 SLA battery capacity while installed in an AED for 3 months at 20° C (68° F) without recharging

To properly maintain SLA battery paks:

- Recharge after each use or once a month, whichever comes first. Maintain a battery recharge record.
- Use only the Medtronic battery charger designed for use with the LIFEPAK 500 AED. Do not use any other charger.
- Recharge until the battery charger charge LED is green. This indicates that the battery charger has completed the fast-charge cycle. Undercharging can cause battery damage.
- Recharge only at temperatures between 15° and 35° C (59° and 95° F).
- Never expose battery paks to temperatures greater than 50° C (122° F).



- Battery paks are best when used and stored between 0° and 35° C (32° and 95° F). Higher temperatures accelerate the loss of charge and wear out the battery pak sooner. Lower temperatures reduce battery capacity.
- Do not allow electrical connection between the battery contacts.

### WARNINGS!

#### Possible loss of power during patient care.

Stored batteries lose charge. Failure to charge a rechargeable battery before use may cause device power failure without warning. Always charge a stored battery before placing it in active use.

#### Possible loss of power during patient care.

Using an improperly maintained battery to power the defibrillator may cause power failure without warning. Use the LIFEPAK 500 battery charger to charge the rechargeable battery pak.

### CAUTIONS!

#### Possible battery damage.

Recharge the battery until the battery charger charge LED is green. Undercharging can cause battery damage.

#### Possible battery damage.

Charging batteries outside the temperature range of 15°–35° C (59°–95° F) may cause improper charging and shorten battery life.



#### Possible battery damage.

Electrical connection between battery contacts can blow an internal fuse and permanently disable the battery.

### Recharging a Rechargeable Battery Pak

The battery charger fully charges a connected SLA battery in about 10 hours. The battery charger applies a high-level, fast charge for the first 10 hours that the battery is connected. If the battery remains connected, the battery charger applies a low-level trickle charge to maintain a full charge. Agency approval markings are provided on the bottom of the battery charger.

To charge a battery:

- 1 Connect the battery charger to an appropriate ac power source (100 to 240 Vac, 50 or 60 Hz). The green LED (marked by the  symbol) appears when the power is connected.
- 2 Connect the battery to the battery charger.
- 3 Confirm that the charge LED (marked by the  symbol) is amber. This indicates that the battery charger is applying a fast charge.
- 4 Wait at least 10 hours. Then, confirm that the charge LED is green. The green LED indicates that the fast-charge cycle is complete and the battery is receiving a trickle charge to maintain full charge.
- 5 Disconnect the battery.

A fully charged battery is not harmed if it remains connected to the battery charger. However, if a battery is disconnected and then reconnected, the battery charger begins the 10 hours of fast charge again. Additional battery charge cycles without discharging can reduce battery life.

### Recycling Rechargeable Batteries

Recycle SLA battery paks locally according to national, regional, and local governmental regulations. If recycling is not possible, contact a Medtronic representative for information or assistance. In the USA, call 1.800.442.1142.

To promote awareness of battery recycling, SLA battery paks are marked with this label:



---

## ELECTRODE STORAGE

For information about defibrillation electrode storage, refer to the operating instructions for the FAST-PATCH and QUIK-COMBO electrodes.

---

## SERVICE AND REPAIR

### WARNING!

#### Shock hazard.

Do not disassemble the defibrillator. It contains no operator serviceable components and dangerous high voltages may be present. Contact authorized service personnel for repair.

If the LIFEPAK 500 AED requires service as indicated by testing, troubleshooting, or the service indicator, contact authorized service personnel. In the USA, call Medtronic Technical Support at 1.800.442.1142. When you call Medtronic to request service, provide the following information:

- Model number and part number
- Serial number
- Observation of the problem that led to the call

If the device must be shipped to a service center or the factory, pack the device in the original shipping container. If this is not possible, ship the device in protective packing to prevent shipping damage.

The *LIFEPAK 500 AED Service Manual* provides detailed technical information to support service and repair by authorized service personnel.

## Product Recycling Information

Recycle the device at the end of its useful life.

- **Recycling Assistance**

The device should be recycled according to national and local regulations. Contact your local Medtronic representative for assistance.

- **Preparation**

The device should be clean and contaminant-free prior to being recycled.

- **Recycling of Disposable Electrodes**

After disposable electrodes are used, follow your local clinical procedures for recycling.

- **Packaging**

Packaging should be recycled according to national and local regulations.

---

## **WARRANTY**

Refer to the product warranty statement included in the accessory kit shipped with the product. For duplicate copies, contact your local Medtronic representative. In the USA, call 1.800.442.1142.

---

## **SUPPLIES, ACCESSORIES, AND TRAINING TOOLS**

Table 5-3 lists supplies, accessories, and training tools for the LIFEPAK 500 AED. For information about ordering, contact your local Medtronic representative. In the USA, call 1.800.442.1142.

Table 5-3 Supplies, Accessories, and Training Tools

<b>Description</b>	<b>CAT.</b>
LIFEPAK 500 nonrechargeable lithium sulfur dioxide battery pak, yellow	11141-000013
LIFEPAK 500 nonrechargeable lithium sulfur dioxide battery pak, yellow, (FAA TSO-C97 aircraft certified)	11141-000014
LIFEPAK 500 nonrechargeable lithium sulfur dioxide battery pak, dark gray	11141-000069
LIFEPAK 500 nonrechargeable lithium manganese dioxide battery pak, yellow	11141-000030
LIFEPAK 500 nonrechargeable lithium manganese dioxide battery pak, yellow (FAA TSO-C142 aircraft certified)	11140-000043
LIFEPAK 500 rechargeable SLA battery pak	11141-000002
QUIK-COMBO pacing/defibrillation/ECG electrodes with REDI-PAK preconnect system	11996-000017
Infant/Child Reduced Energy Defibrillation Electrodes (not compatible with the QUIK-COMBO defibrillation cable or LIFEPAK 500 AEDs without the pink connector)	11101-000016
LIFEPAK 500 battery charger	11140-000002
Medtronic Test Load	11998-000022
QUIK-COMBO Patient Simulator	11202-000007
LIFEPAK 500 Carrying Case (soft)	11998-000014
LIFEPAK 500 Carrying Case (hard)	11998-000021
LIFEPAK 500 Electrode Storage Tray kit	11998-000051
AED Instruction Card	26500-000185
Wall mount bracket	11210-000001
Spare battery pouch kit	11220-000025
<b>Cables:</b>	
LIFEPAK 500 Modem Cable	11150-000001
LIFEPAK 500 PC Cable	11230-000001
Setup Transfer Cable	11110-000050

Table 5-3 Supplies, Accessories, and Training Tools (Continued)

Description	CAT.
<b>Literature:</b>	
<i>LIFEPAK 500 AED Service Manual</i>	26500-000036
<i>Training and Implementation Guide for use with the LIFEPAK 500 automated external defibrillator</i>	26500-000181

## SPECIFICATIONS

Table 5-4 lists the specifications for the biphasic and public safety (DPS) LIFEPAK 500 AEDs. The specifications apply to all LIFEPAK 500 AEDs unless otherwise noted.

Table 5-5 lists the specifications for the LIFEPAK 500 AED Battery Charger.

Table 5-4 LIFEPAK 500 AED Specifications

AED <sup>1</sup>	
Input	ECG via QUIK-COMBO or FAST-PATCH disposable electrodes; standard placement: anterior-lateral; alternate placement: anterior-posterior
Electrical Protection	Input protected against high voltage defibrillator pulses per IEC 60601/EN 60601
Safety Classification	Internally powered equipment IEC 60601-1/EN 60601-1, 5.1
Waveform	Biphasic and DPS: truncated exponential, with voltage and duration compensation for patient impedance <sup>2</sup>
Output Energy Accuracy	±10% into 50 ohms (biphasic) ±15% into 25 to 100 ohms (biphasic)
Output Energy Sequence	Biphasic and DPS: Three levels, user configurable from 200 to 360 joules, delivered (Level 1, Level 2, Level 3, Level 3...)
Charge Time	With a new, nonrechargeable battery pak, or a new, fully charged rechargeable battery pak: 200 joules in less than 9 seconds 360 joules in less than 15 seconds
Controls	
<b>ON/OFF</b>	Turns device power on or off
<b>ANALYZE</b>	Starts ECG analysis. (optional)
<b>SHOCK</b>	Delivers defibrillation energy. Active only when Shock Advisory System advises defibrillation.

<sup>1</sup> All specifications at 20° C (68° F) unless otherwise stated. All performance specifications assume the device has been stored (two hours minimum) at the operating temperature prior to operation.

<sup>2</sup> Specifications apply from 25 to 200 ohms. Voltage compensation is limited to the voltage that would result in delivery of 360 joules into 50 ohms.

Table 5-4 LIFEPAK 500 AED Specifications (Continued)

Clock Set	Two switches, ▲ and ►, are provided to set the clock.
Display	Two-line, 20-character per line dot matrix liquid crystal display
Readiness Display	Biphasic and DPS: Indicates <b>OK</b> when self-test completed successfully
Low Battery Indicator	Low battery icon: At least 11 discharges remaining with nonrechargeable battery pak At least 6 discharges remaining with rechargeable battery pak
Service Indicator	Service icon
Displayed Messages	Messages prompt user through complete operating sequence.
Audible Tones	Coded tones assist user through device operation and alert operator of display messages.
Voice Prompts	Prompt user through complete operation sequence
Color	Biphasic: Yellow DPS: Dark Gray

---

**EVENT DOCUMENTATION**

Type	Internal digital memory
Memory Capacity	20 minutes audio recording (optional) ECG and event log of operator/device actions: – At least 20 minutes if unit is configured with audio recording and audio recording setup option is <b>ON</b> – At least 80 minutes if configured with audio recording and audio recording setup option is <b>OFF</b> – At least 60 minutes if not configured with audio recording
Report Types	CODE SUMMARY report, Event Log report, Test Log report
Capacity	300 Event Log events 30 Test Log device tests (assuming no fault codes)
Communications	Options: – Direct connection to personal computer – Modem connection to personal computer using Hayes AT-Compatible modem
Data Review	LIFENET system compatible. Options: – LIFENET DT EXPRESS information management program – CODE-STAT data management system

Table 5-4 LIFEPAK 500 AED Specifications (Continued)

## ENVIRONMENTAL

Operating Temperature	0°–50° C* (32°–122° F)
Storage Temperature	-30°–65° C* (-22°–149° F) without battery and electrodes -30°–65° C* (-22°–149° F) with battery and electrodes, maximum total exposure time limited to one week
Atmospheric Pressure	760 to 429 mmHg (0 to 15,000 ft above sea level) DPS: MIL-STD-810E, Method 500.3, Procedure II (Operation): -609.6 m to 4,572 m (-2000 ft to 15,000 ft)
Relative Humidity	10 to 95% (non-condensing)
Dust/Water Resistance	IEC 60529/EN 60529 IPX4 (Splash-proof) with electrodes or connector cover installed DPS: IEC 60529/EN 60529 IP54 (Dust/Splash-proof) with electrodes or connector cover installed
Shock	MIL-STD-810E, Method 516.4, Procedure 1 (40 g, 6–9 ms pulse, 1/2 sine each axis) DPS: IEC 60068-2-29 "Bump" (40 g, 600 bumps)
Vibration	MIL-STD-810E, Method 514.4, Helicopter- Category 6 (3.75 g rms) and Ground Mobile - Category 8 (3.15 g rms). RTCA/DO-160C, Table 8-2 Fixed Wing - Turbojet Engine Classification C' (Fuselage). Test level per Figure 8-5 C. 1 hour in each of three axes. DPS: MIL-STD-810F, Method 514.5, Helicopter Operational: Sine/Random (1.58 g rms) 1 hour per axis Storage: Sine/Random (3.10 g rms) 1 hour per axis Jet Aircraft Random (3.54 g rms), 30 min. per axis Turboprop Random (4.87 g rms), 1 hour per axis
Aircraft	RTCA/DO-160D (Environmental Conditions and Test Procedures for Airborne Equipment), Section 21, Category M, (Radiated Emissions)
ESD	Electrostatic Discharge: Exceeds EN60601-1-2 (8 kV contact, 15 kV air)
Salt Fog	DPS: MIL-STD-810E, Method 509.3
EMC	Refer to Appendix D

**Note:** See page 5-7 for information on caring for batteries.

## GENERAL

## Rechargeable SLA battery pak

Type	Sealed lead-acid, 8 V, 2.5 amp hours
Capacity	Typical: 59 full discharges or 3 hours of "on time" at 20° C (68° F) with a new, fully charged battery Minimum: 43 full discharges with a new, fully charged battery

Table 5-4 LIFEPAK 500 AED Specifications (Continued)

Battery Charge Time	10 ±1 hours. Battery charging limited to 15°–35° C (59°–95° F).
Recommended Replacement Interval	Two years or 200 battery charge/discharge cycles, whichever comes first using recommended battery maintenance procedures
Weight	0.9 kg (1.9 lb)
<b>Nonrechargeable battery pak</b>	
Lithium sulfur dioxide (LiSO <sub>2</sub> ) battery	
Type	Sealed lithium, 12V, 7.5 amp-hours
Certification	FAA: TSO-C97 (Battery 3005380-027) CAA: BS2G239 (Battery 3005380-028)
Capacity	Typical: 312 full discharges or 14 hours of “on time” with a new battery Minimum: 230 full discharges with a new battery at 20° C. 0°–58° C (32°–136° F) is a minimum of 197 full discharges with a new battery.
Shelf Life	Five years Four years (TSO-C97 for aircraft use)
Weight	0.5 kg (1.2 lb)
Lithium manganese dioxide (LiMnO <sub>2</sub> ) battery	
Type	Sealed lithium, 12V, 10 amp-hours
Certification	FAA: TSO-C142 (Battery 3201856)
Capacity	Typical: 416 full discharges or 18 hours of “on time” with a new battery Minimum: 306 full discharges with a new battery
Shelf Life	Five years
Weight	0.5 kg (1.2 lb)
<b>Physical Characteristics</b>	
Height	10.2 cm (4.0 in)
Width	26.7 cm (10.5 in)
Depth	29.5 cm (11.6 in) including handle
Weight	2.41 kg (5.3 lb) without battery or electrodes (biphasic)
	Defibrillation protected, type BF patient connection

Table 5-4 LIFEPAK 500 AED Specifications (Continued)

DEFIBRILLATOR

Waveform Biphasic truncated exponential waveform

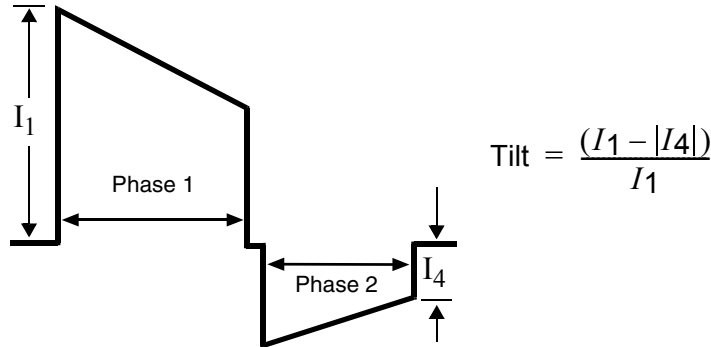

Patient Impedance (Ω)	Phase 1 Duration (ms)		Phase 2 Duration (ms)		Tilt (%)	
	Min	Max	Min	Max	Min	Max
25	5.1	6.0	3.4	4.0	74.8	82.9
50	6.8	7.9	4.5	5.3	63.9	71.0
100	9.5	11.2	6.3	7.4	46.3	51.6

Table 5-5 LIFEPAK 500 AED Battery Charger Specifications

GENERAL

Safety Classification	 Class II (double insulation), IEC 60601/EN 60601, 5.1
Input	100–240 V, 0.7–0.4 A, 50/60 Hz
Output	9.9 Vdc for 10 hours, 9.2 V trickle charge thereafter
Output Protection	Current limited, short circuit protected

ENVIRONMENTAL

Operating Temperature	15°–35° C (59°–95° F)
Water Resistance	IEC 60529/EN 60529 IPX0 (Indoor Use Only)



## CLINICAL SUMMARY: DEFIBRILLATION OF VENTRICULAR FIBRILLATION AND VENTRICULAR TACHYCARDIA

### Background

Medtronic conducted a multi-centered, prospective, randomized and blinded clinical trial of biphasic truncated exponential (BTE) shocks and conventional monophasic damped sine wave (MDS) shocks.<sup>1</sup> Specifically, the equivalence of 200 J and 130 J BTE shocks to 200 J MDS shocks was tested.

### Methods

Ventricular fibrillation (VF) was induced in 115 patients during evaluation of implantable cardioverter defibrillator function and 39 patients during electrophysiologic evaluation of ventricular arrhythmias. After  $19 \pm 10$  seconds of VF, a customized defibrillator delivered an automatically randomized shock. Efficacy was based on success of this shock. To demonstrate equivalence of test shocks to control shocks, the 95% upper confidence limit of the difference in efficacy (95UCLD), control minus test, was required to be less than 10%.

### Results

#### Ventricular Fibrillation

The efficacy of the 200 J BTE shocks was demonstrated to be at least equivalent to the efficacy of 200 J MDS shocks (95UCLD=2%). The difference in success rates of 200 J MDS minus 200 J BTE shocks was -10% (exact 95% confidence interval from -27% to 4%). The 130 J BTE shocks were not demonstrated equivalent to 200 J MDS shocks (95UCLD=22%). However, neither was their efficacy significantly lower than that of the 200 J MDS shocks (statistical power limited by small sample sizes). For all shock types, hemodynamic parameters (oxygen saturation and systolic and diastolic blood pressure) were at or near their pre-induction levels by 30 seconds after successful shocks.

Shock	Ventricular Fibrillation 1st Shock Success	Exact 95% Confidence Interval
200 J MDS	61/68 (90%)	80–96%
200 J BTE	39/39 (100%)	91–100%
130 J BTE	39/47 (83%)	69–92%

#### Ventricular Tachycardia

Seventy-two episodes of ventricular tachycardia (VT), induced in 62 patients, were treated with randomized shocks. High rates of conversion were observed with biphasic and monophasic shocks. Sample sizes were too small to statistically determine the relationship between success rates of the waveforms tested.

Shock	Ventricular Tachycardia 1st Shock Success	Exact 95% Confidence Interval
200 J MDS	26/28 (93%)	77–99%
200 J BTE	22/23 (96%)	78–100%
130 J BTE	20/21 (95%)	76–100%

<sup>1</sup> S.L. Higgins et al., "A comparison of biphasic and monophasic shocks for external defibrillation." *Prehospital Emergency Care*, 2000; 4(4): 305-13.

## Conclusions

In this double-blinded study, the efficacy of the 200J BTE shocks was demonstrated to be at least equivalent to the efficacy of 200J MDS shocks for defibrillation of short duration, electrically-induced VF. However, the comparison of efficacy of 130J biphasic and 200J monophasic shocks for VF was inconclusive. All waveforms tested provided a high rate of termination of VT. The VT sample sizes were too small to statistically determine the relationship between VT success rates of the waveforms tested.

Compared to conventional shocks for VF, we found no positive or negative effect of biphasic shocks for VF on hemodynamic parameters following the defibrillating shock. It is possible that, compared to 200J monophasic shocks, 200J biphasic shocks will in some cases enable earlier termination of VF. Therefore, we conclude that biphasic shocks for VF delivered at conventional energy levels have the potential to improve outcome in resuscitation of patients with cardiac arrest.



## TROUBLESHOOTING

This section describes how to troubleshoot LIFEPAK 500 automated external defibrillator (AED) operating problems. This section also describes screen messages, voice prompts, and event types.

Patient Care	page 6-2
Modem Data Transfer	6-4
Setup Transfer	6-5
Screen Messages	6-5
Voice Prompts	6-7

If you cannot correct the problem, follow these steps:

- Remove the AED from active service.
- Contact authorized service personnel for service and repair.

**PATIENT CARE**

Table 6-1 Troubleshooting During Patient Care

Observation	Possible Cause	Corrective Action
<p>1 <b>CONNECT ELECTRODES</b> message appears.</p>	<p>Inadequate connection to AED.</p> <p>Electrode does not adhere properly to the patient.</p> <p>Electrodes are dry, damaged, or out-of-date.</p>	<ul style="list-style-type: none"> <li>• Check for complete insertion of connector to AED.</li> <li>• Press electrodes firmly on patient's skin.</li> <li>• Clean, shave, and dry the patient's skin as recommended.</li> <li>• Replace the electrodes.</li> </ul>
<p>2 <b>MOTION DETECTED</b> and <b>STOP MOTION</b> messages appear during analysis.</p>	<p>Patient movement.</p> <p>Patient movement because of agonal respirations.</p> <p>Electrical/radio frequency interference.</p> <p>Vehicle motion.</p>	<ul style="list-style-type: none"> <li>• Stop CPR during analysis.</li> <li>• When patient is being manually ventilated, press <b>ANALYZE</b> after complete exhalation.</li> <li>• Press <b>ANALYZE</b> immediately after exhalation.</li> <li>• Move hand-held communication devices or other suspected devices away from the AED when possible.</li> <li>• Stop vehicle during analysis.</li> <li>• Move patient to stable location when possible.</li> </ul>
<p>3 <b>LOW BATTERY</b> message or indicators appear on readiness display and key panel.</p>	<p>Low battery.</p>	<ul style="list-style-type: none"> <li>• If using AED, continue to use and replace battery at earliest convenience. When this indicator first appears, approximately 20% of battery energy remains.</li> <li>• If AED not in use, replace the battery immediately.</li> </ul>
<p>4 <b>REPLACE BATTERY</b> voice prompt or indicator on key panel flashes.</p>	<p>Very low battery.</p>	<ul style="list-style-type: none"> <li>• Replace battery immediately.</li> </ul>
<p>5 Service indicators appear on readiness display and key panel (<b>CALL SERVICE</b> message <i>not</i> displayed).</p>	<p>A fault requiring service.</p>	<ul style="list-style-type: none"> <li>• Continue to use the AED if it is needed. Contact authorized service personnel as soon as possible to repair the AED.</li> </ul>

Table 6-1 Troubleshooting During Patient Care (Continued)

Observation	Possible Cause	Corrective Action
<p>6 Service indicator on key panel flashing and <b>CALL SERVICE</b> message appears.</p> 	A fault requiring immediate service.	<ul style="list-style-type: none"> <li>• Turn AED off and on. If the <b>CALL SERVICE</b> message appears again, remove the AED from active service. Immediately contact authorized service personnel to repair the AED.</li> </ul>
<p>7 AED displays no messages after you repeatedly press <b>ON/OFF</b>.</p>	<p>Depleted battery.</p> <p>AED needs service.</p>	<ul style="list-style-type: none"> <li>• Replace the battery immediately.</li> <li>• Contact authorized service personnel.</li> </ul>
<p>8 <b>CHARGE REMOVED</b> message appears.</p>	<p>Electrode disconnects from patient or AED.</p> <p><b>SHOCK</b> button not pressed within 15 seconds.</p>	<ul style="list-style-type: none"> <li>• Replace electrode and follow AED voice prompts.</li> <li>• Press <b>SHOCK</b> within 15 seconds after the <b>PUSH TO SHOCK</b> message appears.</li> </ul>
<p>9 Displayed time is incorrect.</p>	Time is incorrectly set in the AED.	<ul style="list-style-type: none"> <li>• Change the AED time setting.</li> </ul>
<p>10 Date printed on report is incorrect.</p>	Date is incorrectly set in the AED.	<ul style="list-style-type: none"> <li>• Change the AED date setting.</li> </ul>
<p>11 Displayed messages are faint or flicker.</p>	<p>Low battery power.</p> <p>Out of Temperature Range.</p>	<ul style="list-style-type: none"> <li>• Replace the battery immediately.</li> </ul>
<p>12 Voice prompts sound faint or distorted.</p>	Low battery power.	<ul style="list-style-type: none"> <li>• Replace the battery immediately.</li> </ul>
<p>13 AED operates but LCD is blank.</p>	<p>Operating temperature is too low or too high.</p> <p>LCD not operating properly.</p>	<ul style="list-style-type: none"> <li>• Operate the AED between 0° and 50°C (32°–122°F).</li> <li>• Contact authorized service personnel.</li> </ul>
<p>14 AED turns off or will not turn on.</p>	<p>Depleted battery.</p> <p>Disconnected battery.</p>	<ul style="list-style-type: none"> <li>• Replace the battery immediately.</li> <li>• Install battery.</li> </ul>

## MODEM DATA TRANSFER

Table 6-2 Troubleshooting During Modem Data Transfer

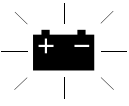
Observation	Possible Cause	Corrective Action
1 <b>BUSY</b> and <b>WILL RE-DIAL IN XX SECONDS</b> messages.	Destination number is busy, the AED is preparing to retry.	<ul style="list-style-type: none"> <li>• Wait for the AED to retry the data transfer.</li> <li>• AED will retry up to three times.</li> </ul>
2 <b>TRY AGAIN, TO SEND PUSH</b> or <b>CANNOT SEND</b> messages.	Transmission failed.	<ul style="list-style-type: none"> <li>• AED will retry up to three times.</li> </ul>
<b>TRY AGAIN, TO SEND PUSH</b> or <b>CANNOT SEND</b> messages. (continued)	Wrong phone number.	<ul style="list-style-type: none"> <li>• Check the destination phone number and <b>MODEM PHONE NUMBER</b> setup option.</li> </ul>
	Cable is not properly connected.	<ul style="list-style-type: none"> <li>• Check connections.</li> </ul>
	Modem is not connected to an analog telephone line.	<ul style="list-style-type: none"> <li>• Confirm that the telephone line is analog (not digital).</li> </ul>
	Incorrect modem selected in Setup menu.	<ul style="list-style-type: none"> <li>• Check modem selected in <b>SETUP OPTIONS</b> menu.</li> </ul>
	Custom Modem Init String is incorrect.	<ul style="list-style-type: none"> <li>• Check <b>MODEM INIT STRING</b>.</li> </ul>
	Dial string for destination site is incorrect.	<ul style="list-style-type: none"> <li>• Check the AED <b>MODEM PHONE NUMBER</b> setup option.</li> </ul>
	Computer power at destination is not on.	<ul style="list-style-type: none"> <li>• Make sure the computer power is on.</li> </ul>
3 <b>CONNECT ELECTRODES</b> message.	Computer application program is not ready.	<ul style="list-style-type: none"> <li>• Make sure the program is ready to receive data.</li> </ul>
	Connection failed or is busy. AED has tried to send data three times.	<ul style="list-style-type: none"> <li>• Resend the data.</li> </ul>
	AED was turned on before modem.	<ul style="list-style-type: none"> <li>• Turn off the AED for one minute. Then, turn on the modem <i>before</i> the AED power and resend the data.</li> </ul>
	4 <b>LOW BATTERY</b>  message or indicators appear on readiness display and key panel.	Low battery.
5 <b>REPLACE BATTERY</b>  voice prompt or indicator on key panel flashes.	Very low battery.	<ul style="list-style-type: none"> <li>• Replace battery immediately.</li> </ul>

## SETUP TRANSFER

Table 6-3 Troubleshooting During Setup Transfer

Observation	Possible Cause	Corrective Action
Original AED displays <b>CANNOT SEND</b> message.	Setup Transfer Cable is not properly connected.	<ul style="list-style-type: none"> <li>Check the connections between the Setup Transfer Cable, the original AED, and the receiving AED.</li> </ul>
	Wrong cable is connected.	<ul style="list-style-type: none"> <li>Connect the Setup Transfer Cable to the original AED and the receiving AED.</li> </ul>
	Receiving AED is not on.	<ul style="list-style-type: none"> <li>Make sure the receiving AED is on.</li> </ul>
	Receiving AED was turned on with electrodes connected or while AED was connected to computer or modem.	<ul style="list-style-type: none"> <li>Turn the receiving AED off and on with the Setup Transfer Cable connected.</li> </ul>
	Receiving AED failed to receive transmission.	<ul style="list-style-type: none"> <li>Turn the receiving AED off and on with the Setup Transfer Cable connected.</li> </ul>

## SCREEN MESSAGES

Table 6-4 LIFEPAK 500 AED Screen Messages

Screen Message	Description
<b>ANALYZING NOW</b>	The AED is analyzing the patient ECG rhythm.
<b>ASYSTOLE</b>	The AED has analyzed the patient's ECG and detected persistent asystole.
<b>ASYSTOLE DETECTOR</b>	Setup mode message for asystole time option.
<b>AUDIO RECORDING</b>	Setup mode message for the audio recording option.
<b>AUTO ANALYZE</b>	Setup mode message for auto analyze options.
<b>BATTERY OK</b>	The battery voltage is ok.
<b>BUSY</b>	While attempting to transfer data by modem, the AED detected that the destination phone number was busy.
<b>CALL SERVICE</b>	The AED detected a fault requiring immediate service during self-tests.
<b>CANNOT SEND</b>	The AED could not transfer the setup, print a report, or transfer data through a modem.
<b>CHARGE REMOVED</b>	The <b>SHOCK</b> button has been disarmed.
<b>CHECK FOR PULSE</b>	AED prompt after each standard three-shock sequence or <b>NO SHOCK ADVISED</b> message when <b>PULSE PROMPT 1</b> is selected in Setup.



Table 6-4 LIFEPAK 500 AED Screen Messages (Continued)

Screen Message	Description
CHECK PATIENT - or - CHECK FOR SIGNS OF CIRCULATION	AED prompt when <b>PULSE PROMPT 2</b> is selected in Setup.
CONNECT ELECTRODES	The AED has detected that the electrodes are disconnected.
CPR TIME XX SEC	Setup mode message for the CPR timer option.
DEVICE ID XXXXXXXX	Setup mode message for device ID option.
ENERGY SEQUENCE #2-XXX	Setup mode message for energy sequence option.
IF NO PULSE	AED prompt that follows the <b>CHECK FOR PULSE</b> message.
IF NOT MOVING AND NOT BREATHING NORMALLY - or - IF NO SIGNS OF CIRCULATION	AED prompt when <b>PULSE PROMPT 2</b> is selected in Setup.
IF YOU WITNESSED THE ARREST, PUSH ►	<b>INITIAL CPR</b> message following <b>START CPR</b> prompt to remind user to deliver a shock immediately if the user witnessed the arrest.
LOW BATTERY	The battery voltage is low.
MODEM INIT STRING XXXXXXXXXXXXXXXXXXXXXXXXXXXX	Setup mode message for the modem initialization string option.
MODEM PHONE NUMBER XXXXXXXXXXXXXXXXXXXXXXXXXXXX	Setup mode message for the modem phone number option.
MODEM SELECTION # XX	Setup mode message. You may select the configuration for one of nine Hayes AT-compatible modems.
MOTION DETECTED	The AED detects motion during ECG analysis, thereby temporarily inhibiting analysis.
MOTION DETECTION	Setup mode message for motion detection option.
NO SHOCK ADVISED	The AED has analyzed the patient ECG and detected a nonshockable ECG rhythm.
PUSH ANALYZE	Press <b>ANALYZE</b> to begin ECG analysis.
PUSH TO SHOCK	The AED is fully charged and ready to provide therapy. This is the AED prompt to press <b>SHOCK</b> to discharge.
REPLACE BATTERY	The battery voltage is very low.
SELF-TEST XX.XX	The self-test is being performed and software version xx.xx is installed.
SEND COMPLETE	The AED successfully transferred data.
SENDING	The AED is transferring the setup to another AED.
SENDING XX% COMPLETE	The AED is transferring data by modem or to a printer. The transfer is xx% complete.

Table 6-4 LIFEPAK 500 AED Screen Messages (Continued)

Screen Message	Description
SETUP MODE nnnnnnnnnnnnnnnnnnnn	The AED is in the setup mode. The nnnnnnnnnnnnnnnnnnn is the Device Configuration code.
SHOCK ADVISED	The AED has analyzed the patient ECG rhythm and detected a shockable ECG rhythm.
STAND CLEAR	The AED prompt to move everyone away from the patient.
START CPR	The AED prompt that follows a <b>NO SHOCK ADVISED</b> decision or after a shock is delivered.
STOP MOTION	See <b>MOTION DETECTED</b> .
TEST MODE	The AED has entered the test mode.
TEST OK	The external test load test has been successfully completed.
TO SEND PUSH ►	The AED is connected to a modem and ready to transfer data.
TRANSFER SETUP TO SEND PUSH ►	Setup mode message for the Transfer Setup feature.
TRY AGAIN	The AED is ready for you to retry transferring data by modem.
WILL RE-DIAL IN XX SECONDS	While attempting to transfer data by modem, the AED detected that the destination phone number was busy. The AED will try again in xx seconds.

**VOICE PROMPTS**

Table 6-5 LIFEPAK 500 AED Voice Prompts

Voice Prompt	Description
ANALYZING NOW, STAND CLEAR	The AED is analyzing the patient ECG rhythm.
ASYSTOLE	The AED has analyzed the patient ECG and detected persistent asystole.
CHECK FOR PULSE	Check the patient for a pulse.
CHECK PATIENT - or - CHECK FOR SIGNS OF CIRCULATION	AED prompt when <b>PULSE PROMPT 2</b> is selected in Setup.
CONNECT ELECTRODES	The AED detects that the electrodes are disconnected.
IF NO PULSE, START CPR	If patient pulse is not present, start CPR.
IF NO PULSE, PUSH ANALYZE	If patient pulse is not present, press <b>ANALYZE</b> .
IF NOT MOVING AND NOT BREATHING NORMALLY - or - IF NO SIGNS OF CIRCULATION	AED prompt when <b>PULSE PROMPT 2</b> is selected in Setup.

Table 6-5 LIFEPAK 500 AED Voice Prompts (Continued)

Voice Prompt	Description
IF YOU WITNESSED THE ARREST, PUSH ►	INITIAL CPR message following START CPR prompt to remind user to deliver a shock immediately if the user witnessed the arrest.
MOTION DETECTED, STOP MOTION	The AED detects motion during ECG analysis.
NO SHOCK ADVISED	The AED has analyzed the patient ECG and detected a non-shockable ECG rhythm.
PUSH ANALYZE	Press ANALYZE to begin ECG analysis.
REPLACE BATTERY	The battery voltage is low and must be replaced immediately.
SHOCK ADVISED	The AED has analyzed the patient ECG and detected a shockable ECG rhythm.
STAND CLEAR	Move away and do not touch patient.
STAND CLEAR, PUSH TO SHOCK	The AED is fully charged and ready to provide therapy. This is the AED prompt to move everyone away from the patient, then press SHOCK to discharge.
START CPR	If you witness the arrest, push right arrow.

## **APPENDIX A SHOCK ADVISORY SYSTEM**

This section describes the basic function of the Shock Advisory System (SAS).



## OVERVIEW OF THE SHOCK ADVISORY SYSTEM

The Shock Advisory System (SAS) is an ECG analysis system built into the LIFEPAK 500 AED that advises the operator if it detects a shockable or nonshockable rhythm. This system makes it possible for individuals not trained to interpret ECG rhythms to provide potentially lifesaving therapy to victims of ventricular fibrillation or pulseless ventricular tachycardia. The Shock Advisory System contains the following features:

- Electrode contact determination
- Automated interpretation of the ECG
- Operator control of shock therapy
- Continuous Patient Surveillance System
- Motion detection

### Electrode Contact Determination

The patient's transthoracic impedance is measured through the defibrillation electrodes. If the baseline impedance is higher than a maximum limit, it is determined that the electrodes are not in sufficient contact with the patient or not properly connected to the AED. ECG analysis and shock delivery are inhibited. The operator is advised to connect electrodes any time electrode contact is inadequate. If you continue to get a **CONNECT ELECTRODES** message, remove electrodes and make sure skin is clean and dry. Shave excessive hair and apply a new set of electrodes.

### Automated Interpretation of the ECG

The Shock Advisory System is designed to recommend a shock if it detects the following:

- **Ventricular fibrillation** — with a peak-to-peak amplitude of at least 0.08 mV
- **Ventricular tachycardia** — defined as having a heart rate of at least 120 beats per minute, QRS width of at least 0.16 seconds, and no apparent P waves.

Pacemaker pulses may prevent advisement of an appropriate shock, regardless of the patient's underlying rhythm. The Shock Advisory System is designed to recommend no shock for all other ECG rhythms, including asystole, pulseless electrical activity, idioventricular rhythms, bradycardia, supraventricular tachycardias, and normal sinus rhythms.

ECG analysis is performed on consecutive 2.7-second segments of ECG. The analysis of two out of three consecutive segments must agree before a decision (**SHOCK ADVISED** or **NO SHOCK ADVISED**) is made.

The LIFEPAK 500 AED's SAS performance for adult and pediatric ECGs is summarized in the following tables.

Table A-1 LIFEPAK 500 AED SAS Performance Table for Adult ECGs

Rhythm Class	ECG Test <sup>1</sup> Sample Size	Performance Goal <sup>2, 3</sup>	Observed Performance Sensitivity or Specificity [LCL] <sup>4</sup>
Shockable: coarse VF	168	>90% sensitivity	100.0% [98.6%]
Shockable: shockable VT	65	>75% sensitivity	84.6% [77.3%]
Nonshockable: NSR	144	>99% specificity for NSR (AHA)	100.0% [98.4%]

Table A-1 LIFEPAK 500 AED SAS Performance Table for Adult ECGs (Continued)

Rhythm Class	ECG Test <sup>1</sup> Sample Size	Performance Goal <sup>2, 3</sup>	Observed Performance Sensitivity or Specificity [LCL] <sup>4</sup>
Nonshockable: asystole	43	>95% specificity	100.0% [94.8%]
Nonshockable: all other rhythms	531	>95% specificity	95.7% [94.3%]
Intermediate: fine VF	29	Report only	86.2% [74.3%] sensitivity

1. From Medtronic ECG database. Each sample is run 10 times asynchronously.
2. Association for the Advancement of Medical Instrumentation. DF39-1993 Standard for Automatic External Defibrillators and Remote-Control Defibrillators. Arlington, VA: AAMI;1993.
3. Automatic External Defibrillators for Public Access Defibrillation: Recommendations for Specifying and Reporting Arrhythmia Analysis Algorithm Performance, Incorporating New Waveforms, and Enhancing Safety. AHA Task Force on Automatic External Defibrillation, Subcommittee on AED Safety and Efficacy. *Circulation*, 1997, Vol. 95, 1677-1682.
4. LCL = 90% exact one-sided lower confidence limit  
VF = ventricular fibrillation  
VT = ventricular tachycardia  
NSR = normal sinus rhythm

The LIFEPAK 500 defibrillator was also tested using ECGs acquired from hospitalized pediatric patients ranging in age from < 1 day old to 17 years old. The results are summarized in Table A-2.

Table A-2 LIFEPAK 500 AED SAS Performance Table for Pediatric ECGs

Rhythm Class	ECG Test <sup>1</sup> Sample Size	Performance Goal <sup>2</sup>	Observed Performance Sensitivity or Specificity [LCL] <sup>3</sup>
Shockable: coarse VF	90	>90% sensitivity	98.9% [95.7%]
Shockable: shockable VT	11	>75% sensitivity	54.5% [31.8%]
Nonshockable: NSR	424	>99% specificity	100.0% [99.5%]
Nonshockable: asystole	95	>95% specificity	100.0% [97.6%]
Nonshockable: all other rhythms	433	>95% specificity	98.8% [97.9%]
Intermediate: fine VF	4	Report only	100.0% [56.2%] sensitivity
Intermediate: other VT	7	Report only	42.9% [17.0%] specificity

1. From Medtronic ECG database.
2. Automatic External Defibrillators for Public Access Defibrillation: Recommendations for Specifying and Reporting Arrhythmia Analysis Algorithm Performance, Incorporating New Waveforms, and Enhancing Safety. AHA Task Force on Automatic External Defibrillation, Subcommittee on AED Safety and Efficacy. *Circulation*, 1997, Vol. 95, 1677-1682.
3. LCL = 90% exact one-sided lower confidence limit.

## Control of Shock Therapy

### Operator Control of Shock Therapy

The Shock Advisory System causes the AED to charge automatically when it detects the presence of a shockable rhythm. When a shock is advised, the operator remains in control of when the shock is delivered.

### Continuous Patient Surveillance System

The Continuous Patient Surveillance System (CPSS) automatically monitors the patient's ECG rhythm for a potentially shockable rhythm while the electrodes are attached and the AED is turned on. CPSS is not active during ECG analysis.

Motion detection is not active during the CPSS. Therefore, there is a chance that motion distortion in the ECG rhythm may be interpreted by CPSS as a potentially shockable rhythm.

### Motion Detection

The Shock Advisory System detects patient motion independent of ECG analysis. A motion detector is designed into the LIFEPAK 500 AED. **MOTION DETECTION** can be configured in the setup mode to be **ON** or **OFF**.

A number of activities can create motion, including CPR, rescuer movement, patient movement, vehicle movement, and some internal pacemakers. If variations in the transthoracic impedance signal exceed a maximum limit, the Shock Advisory System determines that patient motion of some kind is present. If motion is detected, the ECG analysis is inhibited. The operator is advised by a displayed message, a voice prompt, and an audible alert. After 10 seconds, if motion is still present, the motion alert stops and the analysis always proceeds to completion. This limits the delay in therapy in situations where it may not be possible to stop the motion. However, the rescuer should remove the source of motion whenever possible to minimize the chance of artifact in the ECG.

There are two reasons why ECG analysis is inhibited when the motion alert occurs, and why the rescuer should remove the source of the motion whenever possible:

- Such motion may cause artifact in the ECG signal. This artifact may occasionally cause the Shock Advisory System to reach an incorrect decision.
- The motion may be caused by a rescuer's interventions. To reduce the risk of inadvertently shocking a rescuer, the motion alert prompts the rescuer to move away from the patient. This will stop the motion and ECG analysis will proceed.

The motion detection feature can be set to **OFF**. When this option is off, analysis of the ECG is allowed to proceed uninhibited even in the presence of motion, which may or may not cause artifact in the ECG as described previously. Artifact in the ECG can sometimes cause an erroneous shock advisory decision.

The skill and training level of the care providers should be taken into consideration when deciding whether or not to turn off the motion detection feature. How readily do the users respond to the AED voice prompt? For example, do they immediately stop CPR upon hearing the **STAND CLEAR, ANALYZING NOW** prompt?





## **APPENDIX B LIFEPAK 500 OPERATOR'S CHECKLIST**

This Operator's Checklist may be reproduced.



**LIFEPAK® 500**  
**Automated External Defibrillator**  
**OPERATOR'S CHECKLIST**

Unit Serial No.: \_\_\_\_\_

Location: \_\_\_\_\_

This is a suggested checklist for inspecting and checking this device on a daily basis and after each use.

This form may be reproduced.



Instruction	Recommended Corrective Action	Date							
		Initials							

Insert a ✓ in the box after completing each instruction.

**1 Examine the AED case, connector, and battery well for:**

Foreign substances

Clean the device.

--	--	--	--	--	--	--	--

Damage or cracks

Contact authorized service personnel.

--	--	--	--	--	--	--	--

**2 Examine the battery pins for bending or discoloration.**

Discard and replace battery.

--	--	--	--	--	--	--	--

**3 Check expiration date on batteries and therapy electrodes.**

Replace if expired.

--	--	--	--	--	--	--	--

**4 Examine the accessory cables for cracked, damaged, broken, or bent connectors or wires.**

Replace damaged or broken parts.

--	--	--	--	--	--	--	--

**5 With the battery installed, press On/Off to turn on the AED and look for:**

Self-test messages

If absent, contact authorized service personnel.

--	--	--	--	--	--	--	--

Momentary illumination of each LED and all LCD segments

If absent, contact authorized service personnel to repair or replace parts.

--	--	--	--	--	--	--	--

**BATTERY LOW** or **REPLACE BATTERY SELF-TEST XX.XX** message

Replace the battery immediately.

--	--	--	--	--	--	--	--

Service indicator or **CALL SERVICE** message

Contact authorized service personnel.

--	--	--	--	--	--	--	--



**APPENDIX C  
FAST-PATCH DEFIBRILLATION CABLE  
INSTRUCTIONS FOR USE**



**Instructions for Use**

**Introduction**

To use FAST-PATCH disposable defibrillation/ECG electrodes, the LIFEPAK 500 automated external defibrillator (AED) requires this FAST-PATCH defibrillation cable (see Figure C-1).

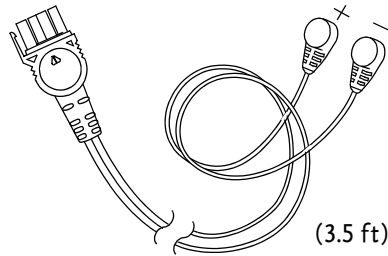

Figure C-1 FAST-PATCH defibrillation cable for the LIFEPAK 500 AED

**WARNING!**  
Inability to deliver therapy.  
Only FAST-PATCH electrodes can be used with the FAST-PATCH defibrillation cable.

**CAUTION!**  
Possible Equipment Damage.  
To prevent water or foreign substance contamination, keep the protective cover for the AED connector closed or the defibrillation cable inserted when the device is not in use.

**Symbols**

The following symbols appear on the defibrillation cable:

- Attention, consult accompanying documents
- +** Positive terminal
- Negative terminal

**Important**

Operators should be thoroughly familiar with the *LIFEPAK 500 AED Operating Instructions* and the *FAST-PATCH Disposable Defibrillation/ECG Electrode Operating Instructions* before using this defibrillation cable.

**Cable Attachment**

A lanyard is provided to help prevent loss of the defibrillation cable.

To attach the lanyard:

- 1 Loop the lanyard around the AED connector-end of the cable (see Figure C-2).
- 2 Loop the defibrillation cable through the lanyard and around the AED handle (see Figure C-2).

- 3 Insert the cable firmly into the AED until a positive stop is felt (see Figure C-3).

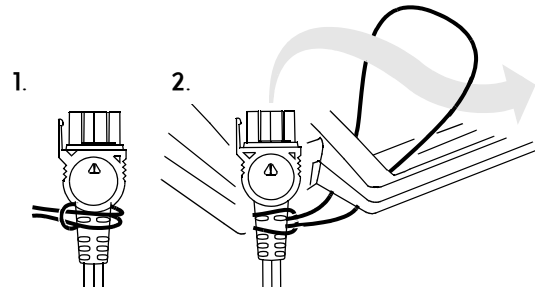

Figure C-2 Attaching lanyard

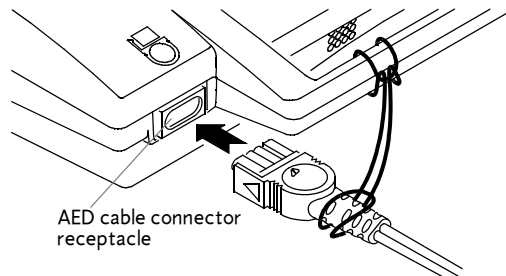

Figure C-3 Inserting defibrillation cable into AED

Remove the defibrillation cable for data transfer by pulling the connector straight out. Reconnect the defibrillation cable to the AED after data transfer, or close the protective cover on the AED cable connector.

**Connecting to FAST-PATCH Defibrillation/ECG Electrodes**

Properly connect the defibrillation cable to the electrodes to help ensure energy delivery (see Figure C-4).

- Attach the cable to the electrode post before attaching electrodes to the patient.
- Support the electrode post under the electrode when attaching the cable to the electrode.
- Firmly press the snap connector onto the electrode post until a click is heard or felt.
- Confirm a secure connection of the cable to the electrode before proceeding with therapy by pulling up gently on the snap connector.

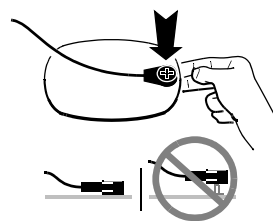

Figure C-4 Connecting to FAST-PATCH defibrillation/ECG electrodes

**Note:** If reattaching an electrode that is already on the patient, lift the adhesive edge under the electrode post slightly and place your finger under the post. Connect the cable as described.



## FAST-PATCH® Defibrillation Cable

for LIFEPAK® 500 Automated External Defibrillator

### Instructions for Use (continued)

---

#### Disconnecting from Disposable Electrodes

Disconnect the defibrillation cable from the electrode by pulling the snap connector straight up and off the post to avoid damage to the cable or the post (see Figure C-5).

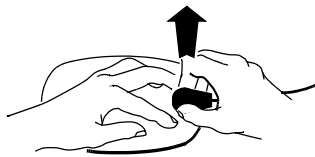

Figure C-5 Disconnecting from electrodes

---

#### Colors and Symbols

The defibrillation cable has colors and symbols on the snap connectors consistent with industry standards:

- AHA standards - red and white
- IEC standards - green and red

The snap connectors are labeled “+” (apex) and “-” (sternum). Refer to the *FAST-PATCH Electrode Operating Instructions* for electrode placement information.

---

#### Cleaning and Testing

To clean the FAST-PATCH defibrillation cable and snap connectors, wipe the surface with any one of the following:

- Mild soap and water
- Isopropyl alcohol
- Peracetic (peroxide) acid solutions
- Quaternary ammonium compounds
- Gluteraldehyde solutions

Contact local infection control resources for specific questions regarding cleaning procedures or cleaning agents available in your area.

- Do not immerse or soak the defibrillation cable.
- Do not use bleach or bleach dilution.
- Do not steam or gas sterilize.

Inspect and test the defibrillation cable on a routine basis. Inspection and testing will help ensure that the equipment is in good operating condition and is ready for use when needed. Use the Medtronic Patient Simulator to test the defibrillation cable.

If any discrepancy is detected with the defibrillation cable during inspection or testing, remove the defibrillation cable from service and immediately contact a qualified service representative.

---

#### Recycling Information

Recycle the device at the end of its useful life.

#### Preparation

The device should be clean and contaminant-free prior to being recycled.

#### Recycling Assistance

The device should be recycled according to national and local regulations. Contact your local Medtronic representative for assistance.

#### Recycling of Disposable Electrodes

After disposable electrodes are used, follow your local clinical procedures for recycling.

#### Packaging

Packaging should be recycled according to local and national regulations.

---

#### Ordering Information

Contact your local Medtronic sales or service office to order parts. In the USA, call the Medtronic PARTSLINE™ at 1.800.442.1142.

- FAST-PATCH defibrillation cable for LIFEPAK 500 AED (MIN 3010493)
- FAST-PATCH disposable defibrillation/ECG electrodes (MIN 3010188)
- Medtronic Patient Simulator (MIN 803499)

**APPENDIX D  
DECLARATIONS OF CONFORMITY / ELECTROMAGNETIC  
COMPATIBILITY GUIDANCE**



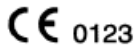

**Declaration Of Conformity**



**Manufacturer's Name:** Medtronic Emergency Response Systems, Inc.  
**Manufacturer's Address:** 11811 Willows Road NE  
 Redmond, WA 98052 USA

declares that the CE-marked product

**Product Name:** LIFEPAK® 500 Automated External Defibrillator  
**Part Number(s):** 3011790 (biphasic only)

complies with 93/42/EEC (Medical Device Directive) as amended by Directives 98/79/EC, 2000/70/EC, 2001/104/EC and EC regulation 1882/2003 class IIb, Conformity assessed per Annex II.

**This product complies with:**

**Safety:**

EN 60601-1:1996/ IEC 60601-1:1995 Internally powered, Type BF, Continuous operation, IPX4.  
 IEC 60601-2-4:1983

**EMC:**

EN 60601-1-2:2001/IEC 60601-1-2:2001\*  
 EN 60601-2-4:2003\*  
 CISPR11:2003 (Amd. A1:2004) Class B, Group 1  
 EN 61000-4-2:2001 8kV CD, 15 kV AD  
 IEC 61000-4-3:2002 10 V/m (20 V/m EN 60601-2-4)\*  
 IEC 61000-4-8:2001 3A/m

**Supplementary Information**

Included are the following accessories and interconnecting cables:

**Power Sources and Test**

Sealed lead-acid battery, MIN 3005379  
 Lithium Battery, MIN 3200390, 3005380, 3201856  
 LIFEPAK 500 Test Load, MIN 3005389

**Therapy**

QUIK-COMBO pacing/defibrillation/ECG electrodes with REDI-PAK™ preconnect system, MIN 3202674  
 QUIK-COMBO™ electrode set, MIN 3010188  
 FAST-PATCH® electrodes, MIN 3010188  
 FAST-PATCH defibrillation cable, MIN 3010493  
 Infant/Child Reduced Energy Defibrillation Electrodes, MIN 3202380  
 QUIK-COMBO Extension Cable, MIN 3009864.

**Non-Medical Accessories**

Data transfer cable, MIN 3005381, 3010779

Redmond, July 26, 2006

Donald R. Ellis  
 Vice President, Quality and Regulatory Affairs

This declaration applies to CE marked devices placed on the market after the date of issuance of this declaration and before it is either superseded by another declaration or withdrawn.

Authorized EC Representative: Medtronic B.V., Earl Bakkenstraat 10, 6422 PJ Heerlen, The Netherlands

\*see EMC tables



Ault Incorporated, 7105 Northland Terrace, Minneapolis, MN 55428-1534, 763-592-1900/Fax 763-592-1911

Visit our web site: [www.aultinc.com](http://www.aultinc.com), or contact us by e-mail: [info@aultinc.com](mailto:info@aultinc.com)



### EC DECLARATION OF CONFORMITY

We hereby declare under our sole responsibility that the product model(s) BCWA-042000-100A and BCWA-042000-100N (MEDTRONIC LIFEPAK 500 Battery Charger), a power supply intended for use as a battery charger in household and other similar applications, to which this declaration relates, meets the requirements of the following New Approach Directives:

- **Electro-Magnetic Compatibility (EMC)** Directive 89/336/EEC
- **Low Voltage Directive (LVD)** 73/23/EEC and 93/68/EEC

This declaration is backed by third party assessment to the appropriate European Norm standards. Ault Incorporated is an ISO 9001 registered firm, Certificate Number FM11881.

Tim Cassidy  
Director, Corporate Engineering  
23 September 2004

Table D-1 Guidance and Manufacturer’s Declaration - Electromagnetic Emissions

Guidance and Manufacturer’s Declaration - Electromagnetic Emissions		
The LIFEPAK® 500 Automated External Defibrillator (AED) is intended for use in the electromagnetic environment specified below. The customer or the user of the LIFEPAK 500 AED should ensure that the defibrillator is used in such an environment.		
Emissions Test	Compliance	Electromagnetic Environment - Guidance
RF emissions CISPR 11	Group 1	The LIFEPAK 500 AED uses RF energy only for its internal function. Therefore, its RF emissions are very low and are not likely to cause any interference in nearby electronic equipment.
RF emissions CISPR 11	Class B	The LIFEPAK 500 AED is suitable for use in all establishments, including domestic establishments and those directly connected to the public low-voltage power supply network that supplies buildings used for domestic purposes.
Harmonic emissions IEC 61000-3-2	Not Applicable	
Voltage fluctuations/ flicker emissions IEC 61000-3-3	Not Applicable	

**Essential Performance**

The LIFEPAK 500 AED maintains safe and effective performance of the defibrillation therapy and patient monitoring functions when operated in the electromagnetic environment specified in Tables D-2 through D-4.

**Limitations Affecting Immunity to Electromagnetic Disturbances**

The level of protection from electromagnetic disturbances is limited by several factors, including requirements for protection from third-party defibrillators, patient safety isolation, and maintenance of adequate signal-to-noise ratios for processing of patient signals.

## Declarations of Conformity / Electromagnetic Compatibility Guidance

Table D-2 Guidance and Manufacturer's Declaration - Electromagnetic Immunity

Guidance and Manufacturer's Declaration - Electromagnetic Immunity			
The LIFEPAK 500 AED is intended for use in the electromagnetic environment specified below. The customer or the user of the LIFEPAK 500 AED should ensure that the defibrillator is used in such an environment.			
Immunity Test	IEC 60601 Test Level	Compliance Level	Electromagnetic Environment - Guidance
Electrostatic discharge (ESD) IEC 61000-4-2	±6 kV contact ±8 kV air	±8 kV contact ±15 kV air	The LIFEPAK 500 AED is suitable for use in a dry environment.
Electrical fast transient/burst IEC 61000-4-4	±2 kV for power supply lines ±1 kV for input/output lines	Not Applicable	Not Applicable
Surge IEC 61000-4-5	±1 kV differential mode ±2 kV common mode	Not Applicable	Not Applicable
Voltage dips, short interruptions and voltage variations on power supply input lines IEC 61000-4-11	<5 % $U_T$ (>95% dip in $U_T$ ) for 0.5 cycle 40% $U_T$ (60% dip in $U_T$ ) for 5 cycles 70% $U_T$ (30% dip in $U_T$ ) for 25 cycles <5 % $U_T$ (>95% dip in $U_T$ ) for 5 s	Not Applicable	Not Applicable
Power frequency (50/60 Hz) magnetic field IEC 61000-4-8	3 A/m	3 A/m	Power frequency magnetic fields should be at levels characteristic of a typical location in a typical commercial or hospital environment.
<b>Note:</b> $U_T$ is the a.c. mains voltage prior to application of the test level.			

Table D-3 Guidance and Manufacturer’s Declaration - Electromagnetic Immunity

Guidance and Manufacturer’s Declaration - Electromagnetic Immunity			
The LIFEPAK 500 AED is intended for use in the electromagnetic environment specified below. The customer or the user of the LIFEPAK 500 AED should ensure that the defibrillator is used in such an electromagnetic environment.			
Immunity Test	IEC 60601 Test Level	Compliance Level	Electromagnetic Environment - Guidance
Conducted RF IEC 61000-4-6	3 Vrms 150 kHz to 80 MHz outside ISM bands <sup>a</sup>	Not Applicable	Portable and mobile RF communications equipment should be used no closer to any part of the LIFEPAK 500 AED, including cables, than the recommended separation distance calculated from the equation applicable to the frequency of the transmitter.  Recommended separation distance Not Applicable
	10 Vrms 150 kHz to 80 MHz in ISM bands <sup>a</sup>	Not Applicable	Not Applicable
Radiated RF IEC 61000-4-3	10 V/m 80 MHz to 2.5 GHz	10 V/m 80 MHz to 870 MHz, 910 MHz to 1500 MHz, 1624 MHz to 2.5 GHz  3 V/m 870 MHz to 910 MHz, 1500 MHz to 1624 MHz	$d = 1.2 \sqrt{P}$ 80 MHz to 800 MHz $d = 2.3 \sqrt{P}$ for specified frequencies in the range 800 MHz to 2.5 GHz  $d = 7.7 \sqrt{P}$ for specified frequencies  Where $P$ is the maximum output power rating of the transmitter in watts (w) according to the transmitter manufacturer and $d$ is the recommended separation distance in meters (m). <sup>b</sup> Field strengths from fixed RF transmitters, as determined by an electromagnetic site survey, <sup>c</sup> should be less than the compliance level in each frequency range. Interference may occur in the vicinity of equipment marked with the following symbol:  
<b>Note 1:</b> At 80 MHz and 800 MHz, the higher frequency range applies.			
<b>Note 2:</b> These guidelines may not apply in all situations. Electromagnetic propagation is affected by absorption and reflection from structures, objects and people.			

<sup>a</sup> The ISM (industrial, scientific and medical) bands between 150 kHz and 80 MHz are 6,765 MHz to 6,795 MHz; 13,553 MHz to 13,567 MHz; 26,957 MHz to 27,283 MHz; and 40,66 MHz to 40,70 MHz.

<sup>b</sup> The compliance levels in the ISM frequency bands between 150 kHz and 80 MHz and in the frequency range 80 MHz to 2.5 GHz are intended to decrease the likelihood that mobile/portable communications equipment could cause interference if it is inadvertently brought into patient areas. For this reason, an additional factor of 10/3 is used in calculating the recommended separation distance for transmitters in these frequency ranges.

<sup>c</sup> Field strengths from fixed transmitters, such as base stations for radio (cellular/cordless) telephones and land mobile radios, amateur radio, AM and FM radio broadcast and TV broadcast cannot be predicted theoretically with accuracy. To assess the electromagnetic environment due to fixed RF transmitter, an electromagnetic site survey should be considered. If the measured field strength in the location in which the LIFEPAK 500 AED is used exceeds the applicable RF compliance level above, the LIFEPAK 500 AED should be observed to verify normal operation. If abnormal performance is observed, additional measures may be necessary, such as re-orienting or relocating the LIFEPAK 500 AED.



Table D-4 Recommended Separation Distances

Recommended Separation Distances between Portable and Mobile RF Communications Equipment and the LIFEPAK 500 AED				
The LIFEPAK 500 AED is intended for use in an electromagnetic environment in which radiated RF disturbances are controlled. The customer or the user of the LIFEPAK 500 AED can help prevent electromagnetic interference by maintaining a minimum distance between portable and mobile RF communications equipment (transmitters) and the LIFEPAK 500 AED as recommended below, according to the maximum output power of the communications equipment.				
Rated maximum output power of transmitter W	Separation distance according to frequency of transmitter m			
	150 kHz to 80 MHz	80 MHz to 800 MHz $d = 1.2 \sqrt{P}$	80 MHz to 870 MHz, 910 MHz to 1500 MHz, 1624 MHz to 2.5 GHz $d = 2.3 \sqrt{P}$	870 MHz to 910 MHz, 1500 MHz to 1624 MHz $d = 7.7 \sqrt{P}$
0.01	Not Applicable	0.12	0.23	0.77
0.1	Not Applicable	0.38	0.73	2.43
1	Not Applicable	1.2	2.3	7.7
10	Not Applicable	3.8	7.3	24.3
100	Not Applicable	12	23	77
For transmitters rated at a maximum output power not listed above, the recommended separation distance $d$ in meters (m) can be determined using the equation applicable to the frequency of the transmitter, where $P$ is the maximum output power rating of the transmitter in watts (W) according to the transmitter manufacturer.				
<b>Note 1:</b> At 80 MHz and 800 MHz, the separation distance for the higher frequency range applies.				
<b>Note 2:</b> The ISM (industrial, scientific and medical) bands between 150 kHz and 80 MHz are 6,765 MHz to 6,795 MHz; 13,553 MHz to 13,567 MHz; 26,957 MHz to 27,283 MHz; and 40,66 MHz to 40,70 MHz.				
<b>Note 3:</b> An additional factor of 10/3 is used in calculating the recommended separation distance for transmitters in the ISM frequency bands between 150 kHz and 80 MHz and in the frequency range 80 MHz to 2.5 GHz to decrease the likelihood that mobile/portable communications equipment could cause interference if it is inadvertently brought into patient areas.				
<b>Note 4:</b> These guidelines may not apply in all situations. Electromagnetic propagation is affected by absorption and reflection from structures, objects and people.				

## INDEX

### A

#### Accessories

- Battery charger, 2-4
- Battery paks, 2-4
- Carrying case, 2-4
- Catalog numbers, 5-14
- Cleaning, 5-4
- Data cable, 2-4
- Inspection, 5-2
- Ordering, 5-14
- Part numbers, 5-14
- QUIK-COMBO electrodes, 2-4
- Setup Transfer Cable, 2-4
- Test load, 2-4

#### AED (automated external defibrillator)

- Accessories, illustrations and descriptions, 2-4
- Battery maintenance, 5-7
- Cleaning, 5-4
- Connecting electrodes, 2-17
- Features, 2-2
- Initial inspection, 2-2
- Inspection procedure, 5-2
- Maintenance schedule, 5-2

- Overview of data storage and retrieval, 4-2
- Preparing for use, 3-2
- Procedures for analysis and defibrillation, 3-5
- Service and repair guidelines, 5-13
- Storage recommendations, 5-17
- Supplies and accessories, 5-14
- Testing, 5-4
  - Auto tests, 5-5
  - Self-test at power-on, 5-5
- Types of data and retrieval methods, 4-5
- Unpacking, 2-2
- AED (automated external defibrillator) setup options. *See* **Setup options**, 2-7
- AED carrying case, 2-4
- Analysis cycle, 3-5
- ANALYZE button description, 2-2
- Arrow button descriptions, 2-3
- Asystole detector, 3-8

- Asystole Detector option, 2-11
- Audio Alert option, 2-12
- Audio prompt definitions, 6-7
- Audio recording
  - Definition, 4-3
- Audio Recording option, 2-11
- Auto Analyze option, 2-9
- Auto tests, 5-5
  - Daily auto test, 5-5
  - Extended auto test, 5-6

### B

#### Batteries

- Installing, 2-5
- Low battery detection, 2-6
- Low battery indicator, 2-3
- Maintenance, 5-7
- Recharging, 5-12
- Recycling rechargeable battery paks, 5-13
- Removing, 2-5
- Battery charger, 2-4
- Battery compartment, 2-3
- Battery maintenance
  - Rechargeable Battery Pak, 5-11

- Buttons
  - ANALYZE, 2-2
  - Arrows, 2-3
  - Illustration, 2-2
  - ON/OFF, 2-2
  - SHOCK, 2-3
- C**
- Cables
  - Connector receptacle, 2-3
  - Data, 2-4
  - Setup transfer, 2-4
- Cautions
  - Definition, 1-2
  - General caution, 1-3
- Charging battery, 5-12, 5-15
- Cleaning the AED, 5-4
- Clock
  - Changing the time and date, 2-6
- CODE SUMMARY data, 4-3
- Cold start description, 5-5
- Configuration code
  - description, 2-13
- Configuring the AED. *See* **Setup options**
- Connector cover, 2-3
- Continuous Patient Surveillance System. *See* **CPSS**
- Controls, indicators, connectors
  - Illustration and descriptions, 2-2
- CPR countdown timer, 3-6
- CPR Time options, 2-10
- cprMAX Technology, 1-xi
- CPSS, 1-xii
  - Shock Advisory System, A-3
- Current patient record
  - Creating a new Current Patient Record, 4-4
  - Definition, 4-3
- D**
- Daily auto test, 5-5
- Data Retrieval
  - By a direct connection to a computer
    - Equipment connections, 4-9
    - Procedure, 4-9
    - Required resources, 4-8
    - Troubleshooting, 4-9
  - By modem to computer
    - Required resources, 4-5
- Setup options, 4-6
- Data storage, 4-2
- Data storage and retrieval
  - Overview, 4-2
  - Types of data and retrieval method, 4-5
- Date/time setting, 2-6
- Default settings, 2-12
- Defibrillation
  - General information, 1-x
  - Defibrillation procedures, 3-5
  - Device ID option, 2-7
  - Device Tracking, 1-ii
  - Dial string character descriptions, 2-7
  - Dial string for modem, 2-7
  - Discharging nonrechargeable batteries paks, 5-10
  - Display Energy option, 2-9
  - Disposing of nonrechargeable batteries paks, 5-10
- E**
- ECG analysis
  - Mode, 1-xii
  - Preparation, 3-3
  - Procedures, 3-5
- Electrode placement
  - Special situations, 3-4
- Electrodes
  - CONNECT ELECTRODES message, 3-8
  - Connecting to the AED, 2-17
  - Infant/Child, 2-18
  - Storage, 5-13
- Energy Protocol option, 2-8
- Energy Sequence option, 2-8
- Equipment connections, 4-7, 4-9
- Event Log data, 4-2
- Extended auto test, 5-6
- G**
- Guidelines for using the AED, 1-xi
- H**
- Hazard communications,
  - Definitions of terms, 1-2
- I**
- Incident ID, 4-7
- Incident ID option, 2-12
- Incident. *See* **Patient Records**
- Initial CPR
  - Setup options, 2-9
  - Initial CPR option, 2-9
  - Initial CPR Time option, 2-10
  - Inspection procedure, 5-2
  - Intended use statements, 1-x
- L**
- LCD description, 2-3
- Location tracking of defibrillators, 1-ii
- Low battery detection, 2-6
- Low battery indicator
  - Description, 2-3
- M**
- Maintenance and testing schedule
  - for operators, 5-2
- Microphone, 2-3
- Modem dial string, 2-7
- Modem Init String option, 2-8
- Modem Phone Number option, 2-7
- Modem Selection option, 2-7
- Motion detection
  - Description, 1-xii
  - During ECG analysis, 3-7
  - Setup options, 2-11
  - Shock Advisory System, A-3
  - Troubleshooting, 6-2
- N**
- NO SHOCK ADVISED message, 3-6
- Nonrechargeable battery pak, 5-8
  - Discharging, 5-10
  - Disposing, 5-10
  - Maintenance, 5-8
- O**
- ON/OFF button description, 2-2
- Operator's Checklist, B-1
- Ordering replacement parts, 5-14
- P**
- Parts and supplies, 5-14
- Patient Records
  - Current Patient Record, 4-3
  - Definition, 4-3
  - Previous Patient Record, 4-3
- Patient records
  - Creating a new patient record,

- 4-4
  - Patient transfer and QUIK-COMBO electrodes, 3-9
  - PC Data cable
    - Connection, 4-9
  - Power, Low battery indicator, 2-6
  - Power-on self test, 5-5
  - Preparing the AED for use, 3-2
  - Pre-shock CPR Time options, 2-10
  - Previous Patient Record,
    - Definition, 4-3
  - Pulse Check option, 2-11
  - Pulse Prompt option, 2-11
- Q**
- QUIK-COMBO electrodes
    - Connecting to AED, 2-17
    - Description, 2-4
    - Patient transfer, 3-9
- R**
- Readiness display, 2-3
  - Rechargeable battery pak
    - General description, 2-4
    - Maintenance, 5-11
    - Recharging, 5-12
    - Recycling, 5-13
  - Recycling rechargeable battery paks, 5-13
  - Repair, 5-13
  - Replacement parts, 5-14
  - Rhythm analysis cycle, 3-5
- S**
- SAS (Shock Advisory System),
    - Overview, A-1
  - Schedule for maintenance and testing, 5-2
  - Screen messages
    - Definitions, 6-5
  - Self test at power-on, 5-5
  - Sending data to a computer
    - By direct connection, 4-8
    - By modem, 4-5
  - Service guidelines, 5-13
  - Service indicator, 5-16
    - Description, 2-3
  - Service indicator and message,
    - 5-4
  - Setting the clock, 2-6
  - Setup options
    - Asystole Detector, 2-11
    - Audio Alert, 2-12
    - Audio Recording, 2-11
    - Auto Analyze, 2-9
    - Changing, 2-13
    - CPR Times, 2-10
    - Default settings, 2-12
    - Device ID, 2-7
    - Display Energy, 2-9
    - Energy Protocol, 2-8
    - Energy Sequence, 2-8
    - Incident ID, 2-12
    - Initial CPR, 2-9
    - Initial CPR Time, 2-10
    - Modem Init String, 2-8
    - Modem Phone Number, 2-7
    - Modem Selection, 2-7
    - Motion Detection, 2-11
    - Pre-shock CPR Time, 2-10
    - Pulse Check, 2-11
    - Pulse Prompt, 2-11
    - Special, 3-8
    - Stack Shocks, 2-9
    - Transfer Setup, 2-12
  - Setup transfer, 2-16
  - Setup Transfer cable
    - Connection, 2-17
    - Description, 2-4
  - SHOCK ADVISED message, 3-6
  - Shock Advisory System. *See* SAS
  - SHOCK button description, 2-3
  - Shock Counter, 3-7
  - Shock therapy, A-3
  - Speaker, 2-3
  - Stack Shocks option, 2-9
  - Storage recommendations, 5-17
  - Supplies and accessories, 5-14
  - Symbol definitions, 1-3
- T**
- Test load
    - Description, 2-4
    - Test, 5-6
  - Test Log report, 4-5
  - Test mode message, 5-6
  - Testing
    - Test load, 5-6
  - Testing the AED, 5-4
    - Auto tests, 5-5
      - Daily auto test, 5-5
      - Extended auto test, 5-6
    - Self test at power-on, 5-5
    - Service indicator and message,
      - 5-5
  - Time/date setting, 2-6
  - Training tools, 5-14
  - Transfer Setup option, 2-12, 2-16
  - Transferring modem data
    - Troubleshooting, 6-4
  - Transferring setup
    - Troubleshooting, 6-5
  - Troubleshooting
    - During modem data transfer,
      - 6-4
    - During patient care, 6-2
    - During setup transfer, 6-5
    - Screen messages, 6-5
    - Voice prompts, 6-7
- U**
- Unpacking the AED, 2-2
- V**
- Voice prompt definitions, 6-7
- W**
- Warnings
    - Electrode use, 3-2
    - General warnings, 1-2
  - Warnings and cautions, Definitions of terms, 1-2
  - Warranty, 5-14
  - Wrench symbol
    - Description, 2-3



**USA Device Tracking**

The U.S. Food and Drug Administration classifies defibrillators as a medical device that requires tracking (knowing where the device is). As such, federal regulations require that manufacturers maintain tracking information for each device distributed. We rely on our customers to provide accurate device location information. This tracking information provides the manufacturer the ability to locate the device and perform a product correction, should it ever be needed.

Tracking information must specify the physical location of the device, not just the headquarters or receiving department's shipping address. The tracking information required is:

- 1 Customer name and department name
- 2 Physical address (actual physical location, for example, 123 Main Street, Third Floor, Suite A)
- 3 City, State, and Zip Code
- 4 A contact name and telephone number
- 5 Device part number and serial number

The address to which this particular device was shipped is the current tracking location. If this device is located somewhere other than the shipping address, or you have purchased this device from someone other than Medtronic, please either call the device tracking coordinator at 1.800.426.4448, or use one of the postage-paid address change cards below to update this vital information.

**Device Tracking Change Information**

<b>1</b>	Customer Name	Department Name
<b>2</b>	Physical Address (Please, no PO Box numbers)	
<b>3</b>	City	State Zip
<b>4</b>	Contact Name	Telephone Number
<b>5</b>	Device Part Number	Serial Number

**Device Tracking Change Information**

<b>1</b>	Customer Name	Department Name
<b>2</b>	Physical Address (Please, no PO Box numbers)	
<b>3</b>	City	State Zip
<b>4</b>	Contact Name	Telephone Number
<b>5</b>	Device Part Number	Serial Number

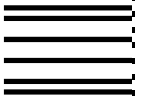

NO POSTAGE  
NECESSARY  
IF MAILED  
IN THE  
UNITED STATES

**BUSINESS REPLY MAIL**

FIRST CLASS PERMIT NO. 64 REDMOND, WA

Postage will be paid by addressee

Device Tracking Coordinator  
**MEDTRONIC**

P. O. Box 97006  
Redmond, WA 98073-9706



NO POSTAGE  
NECESSARY  
IF MAILED  
IN THE  
UNITED STATES

**BUSINESS REPLY MAIL**

FIRST CLASS PERMIT NO. 64 REDMOND, WA

Postage will be paid by addressee

Device Tracking Coordinator  
**MEDTRONIC**

P. O. Box 97006  
Redmond, WA 98073-9706

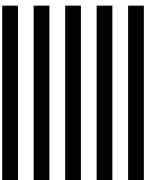





**Medtronic Emergency Response Systems**

11811 Willows Road Northeast  
Redmond, WA 98052-2003 USA  
Telephone: 425.867.4000  
Toll Free (USA only): 800.442.1142  
Fax: 425.867.4121  
Internet: [www.medtronic-ers.com](http://www.medtronic-ers.com)  
[www.medtronic.com](http://www.medtronic.com)

**Medtronic Europe S.A.**

Medtronic Emergency Response Systems  
Rte. du Molliau 31  
Case postale 84  
1131 Tolochenaz  
Switzerland  
Telephone: 41.21.802.7000  
Fax: 41.21.802.7900

MIN 3005338-011 / CAT. 26500-002364

HEART AND VASCULAR DISEASE • NEUROLOGICAL DISORDERS • PAIN • SPINAL DISORDERS • DIABETES  
UROLOGIC DISORDERS • DIGESTIVE SYSTEM DISORDERS • EYE, EAR, NOSE AND THROAT DISORDERS



**Medtronic**

*Alleviating Pain • Restoring Health • Extending Life*

**800.544.0048** [www.AEDSuperstore.com](http://www.AEDSuperstore.com)